



**BRITISH SCHOOL OF ARCHAEOLOGY
IN EGYPT**

AND EGYPTIAN RESEARCH ACCOUNT
EIGHTEENTH YEAR, 1912

**TARKHAN I
AND
MEMPHIS V**

BY

W. M. FLINDERS PETRIE

G. A. WAINWRIGHT

AND

A. H. GARDINER

LONDON

SCHOOL OF ARCHAEOLOGY IN EGYPT
UNIVERSITY COLLEGE, GOWER STREET, W.C.

AND

BERNARD QUARITCH

11, GRAFTON STREET, NEW BOND STREET, W.

1913

PT

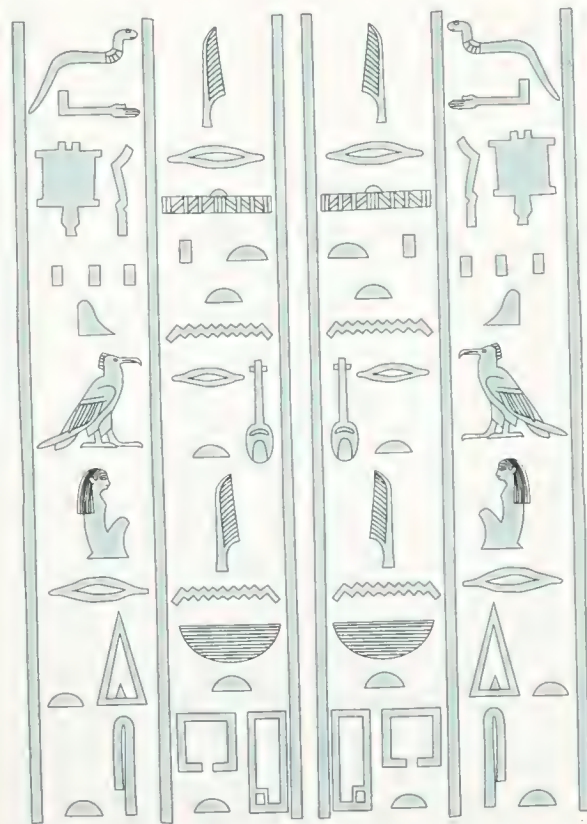

BRITISH SCHOOL OF ARCHAEOLOGY IN EGYPT
AND EGYPTIAN RESEARCH ACCOUNT
NINETEENTH YEAR, 1913

TARKHAN I
AND
MEMPHIS V

BY

W. M. FLINDERS PETRIE

HON. D.C.L., LL.D., LITT.D., PH.D.

F.R.S., F.B.A., HON. F.S.A. (SCOT.), A.R.I.B.A.

MEMBER OF THE ROYAL IRISH ACADEMY

MEMBER OF THE IMPERIAL GERMAN ARCHAEOLOGICAL INSTITUTE

CORRESPONDING MEMBER OF THE SOCIETY OF ANTHROPOLOGY, BERLIN

MEMBER OF THE ITALIAN SOCIETY OF ANTHROPOLOGY

MEMBER OF THE ROMAN SOCIETY OF ANTHROPOLOGY

MEMBER OF THE SOCIETY OF NORTHERN ANTIQUARIES

MEMBER OF THE AMERICAN PHILOSOPHICAL SOCIETY

EDWARDS PROFESSOR OF EGYPTOLOGY, UNIVERSITY OF LONDON

G. A. WAINWRIGHT, B.A.

AND

A. H. GARDINER, D.LITT.

LONDON

SCHOOL OF ARCHAEOLOGY IN EGYPT
UNIVERSITY COLLEGE, GOWER STREET, W.C.

AND

BERNARD QUARITCH

11 GRAFTON STREET, NEW BOND STREET, W.

1913

INSTITUTE OF FINE ARTS
LIBRARY

DT

57. B⁴

14. 23

PRINTED BY
HAZELL, WATSON AND VINEY, LD.,
LONDON AND AYLESBURY.

BRITISH SCHOOL OF ARCHAEOLOGY IN EGYPT AND EGYPTIAN RESEARCH ACCOUNT

Patrons:

VISCOUNT KITCHENER, G.C.B., O.M., G.C.S.I., etc.
THE EARL OF CROMER, G.C.B., G.C.M.G., K.C.S.I., etc.

GENERAL COMMITTEE (*Executive Members)

LORD AVEBURY	Prof. PERCY GARDNER	Sir C. SCOTT MONCRIEFF
WALTER BAILY	Rt. Hon. Sir G. T. GOLDIE	ROBERT MOND
HENRY BALFOUR	Prof. GOWLAND	Prof. MONTAGUE
FREIHERR VON BISSING	F.-M. LORD GRENFELL	WALTER MORRISON
Dr. T. G. BONNEY	Mrs. J. R. GREEN	*Miss M. A. MURRAY
Prof. R. C. BOSANQUET	Mrs. F. LL. GRIFFITH	Prof. P. E. NEWBERRY
Rt. Hon. JAMES BRYCE	Dr. A. C. HADDON	F. W. PERCIVAL
*Prof. J. B. BURY (<i>Chairman</i>)	JESSE HAWORTH	Dr. PINCHES
*SOMERS CLARKE	Dr. A. C. HEADLAM	Dr. G. W. PROTHERO
EDWARD CLODD	D. G. HOGARTH	Dr. G. REISNER
Prof. BOYD DAWKINS	Sir H. H. HOWORTH	Sir W. RICHMOND
Prof. Sir S. DILL	Baron A. VON HÜGEL	Prof. F. W. RIDGEWAY
*Miss ECKENSTEIN	Mrs. C. H. W. JOHNS	Mrs. STRONG
Dr. GREGORY FOSTER	Prof. MACALISTER	Mrs. TIRARD
Dr. J. G. FRAZER	Dr. R. W. MACAN	E. TOWRY WHYTE
*Dr. ALAN GARDINER	Prof. MAHAFFY	
*Prof. ERNEST GARDNER	*J. G. MILNE	

Honorary Treasurer—*H. SEFTON-JONES

Honorary Director—Prof. FLINDERS PETRIE

Honorary Secretaries—Mrs. HILDA PETRIE and *Dr. J. H. WALKER

Bankers—THE ANGLO-EGYPTIAN BANK.

The need of providing for the training of students is even greater in Egypt than it is in Greece and Italy; and the relation of England to Egypt at present makes it the more suitable that support should be given to a British School in that land. This body is the only such agency, and is also the basis of the excavations of Prof. Flinders Petrie, who has had many students associated with his work in past years. The great enterprise of the excavation of the temples and city of Memphis, which is continued year by year, promises the most valuable results. This labour will necessarily be far more costly than any other work in Egypt, and it cannot be suitably carried out without increasing the present income of the School. Active support is required to ensure the continuance of such work, which depends entirely on personal contributions, and each subscriber receives the annual volume. The antiquities not retained by the Egyptian Government are presented to Public Museums, after the Annual Exhibition, in June and July, at University College. The accounts are audited by a Chartered Accountant, and published in the Annual Report. Treasurer: H. SEFTON-JONES.

ADDRESS THE HON. SECRETARY,

BRITISH SCHOOL IN EGYPT, UNIVERSITY COLLEGE,

GOWER STREET, LONDON, W.C.

CONTENTS

TARKHAN		SECT.	PAGE
INTRODUCTION		17. Graves of S.D. 78	8
SECT.	PAGE	18. " " 79	9
1. Sites and staff	1	19. " " 80	10
CHAPTER I		20. " " 81	11
THE DATING OF THE GRAVES		21. " undated	13
2. Need of a fresh <i>corpus</i>	1	CHAPTER IV	
3. <i>Corpus</i> series required	1	MASTABA 1060	
4. Form of the <i>corpus</i>	2	<i>By GERALD WAINWRIGHT</i>	
5. Classing of the pottery and stone vases	2	22. Outside of mastaba	13
6. Registers of results	3	23. Plan of mastaba	14
7. Utilising of Turah results	4	24. The pits	14
CHAPTER II		25. The roofing	15
CHANGES IN THE EARLIEST DYNASTIES		26. The cubit used	15
8. Direction of burial	5	27. Contents of the chambers	15
9. Size of graves	5	28. Dating of the mastaba	16
10. Proportions of sexes	6	29. Description of plates	16
11. Forms of coffins	6	30. Foreign pottery	17
12. Funeral furniture	6	31. Views of mastaba	18
13. Summary	7	32. Objects found	18
CHAPTER III		33. Earlier and later pottery	19
CONTENTS OF THE GRAVES		34. Relation of arts to races	20
14. Mode of record	7	CHAPTER V	
15. General characters	8	OBJECTS FOUND IN THE CEMETERY	
16. Graves of S.D. 77	8	35. Varied small objects, pls. i-iii	20
		36. Tools, pls. iv-vii	23
		37. Woodwork, pls. viii-xii	23
		38. Ivory, pls. xiii-xiv	25

CHAPTER VI

THE BURIALS

SECT.	PAGE
39. Description of pls. xxi-xxviii	26

CHAPTER VII

SLATES, MARKS, CORPUS, AND REGISTERS

40. Slates, pottery marks, pls. xxix-xxxi	27
41. <i>Corpus</i> of stone and pottery, pls. xxxii-lix	28
42. The register of graves, pls. lx-lxviii	29
43. The plans, pls. lxix-lxxvi	29

INDEX	37
-----------------	----

MEMPHIS

CHAPTER VIII

THE EXCAVATIONS

SECT.	PAGE
44. The north gateway	32
45. Monuments found	32

CHAPTER IX

THE INSCRIPTION OF AMENHOTEP

By ALAN H. GARDINER, D.Litt.

46. The translation	33
47. The temple of Amenhotep III	35
48. The endowments	36

LIST OF PLATES

WITH PAGE REFERENCES TO THE DESCRIPTIONS

TARKHAN	PAGES		PAGES
i. View, stone, copper, etc.	20, 21	xxx. Pottery inscriptions and marks	28
ii. Sealings, armlets, coffin, etc.	21, 22	xxxii to	
iii. Ptah bowl, <i>sa</i> case, scarab, flint armlets zebra	22	xliv. Stone vases, <i>corpus</i>	3, 28
iv. Copper tools	23	xlv. Types and dates of stone vases	28
v. Copper tools	23	xlvi to	
vi. Copper tools, horn armlet	23	lviii. Pottery vases, <i>corpus</i>	2, 28
vii. Worked flints, copper bowls	23	lix. Types and dates of pottery	28
viii. Bed-frames, walking-sticks	23, 24	lx. Tarkhan, details of burials S.D. 77	7, 8, 29
ix. House timbers, bed-frame, arrows	24	lxi. " " " " 78	29
x. " " baskets, matting	25	lxii. Turah " " " 78	29
xi. Woodwork	25	lxiii. Tarkhan " " " 79	29
xii. Flint, ivory, and woodwork	25	lxiv. " " " " 80	29
xiii. Ivory spoons	25	lxv. Turah " " " 80	29
xiv. Ivory and beads	25	lxvi. Tarkhan " " " 81	29
xv. Mastaba 1060	13-15	lxvii. " etc. " " " 81-2	29
xvi. " chambers, etc.	14, 15	lxviii. Conversion table	29
xvii. " objects	15, 16	lxix. Position map, and cemetery plan	29
xviii. " plan	15	lxx. Cemetery, hill A	29
xix. " section and objects	15, 16	lxxi. " hills B, C, D	29
xx. " pottery	16	lxxii. " hill E	29
xxi. Graves of Tahuti-mer, Ka, Nar-mer-tha.	26	lxxiii. " hills F, G, H	29
xxii. Graves 170, 1034, 1007, 1035	26	lxxiv. " hill J	29
xxiii. Roofing of graves	26	lxxv. " hills K, L, M, N, O	29
xxiv. Coffins 175	26	lxxvi. " " P, Q, R, S	29
xxv. Graves unopened and opened	26, 27		
xxvi. Basket burials 529, 1004	27	MEMPHIS	
xxvii. Coffins i—vi dyn.	27	lxxvii. Lintel of Amenemhat III	32
xxviii. Coffin 532	27	Group of Ramessu II and Ptah	32
xxix. Slate palettes	27	lxxviii. Sculptures, xix—xxvi dyn.	32, 33
xxx. Clay sealings and pottery marks	28	lxxix. Inscription of Amenhotep	33-36
		lxxx. " "	33-36
		lxxx. Map of sites.	

TARKHAN

INTRODUCTION

1. THE sites of work in the season 1911-12 were varied. In December the ruins of a town a few miles south of Helwan—about 20 miles south of Cairo—were excavated. It bears now the name of Shurafeh; and as a late Roman camp was found there it appears to be the Scenas Mandras of the Itineraries. After about a month of clearing the history of that site, a few days were spent at Atfieh, but it was found that the limits officially stated for our work were inexact, and we accordingly left the site, and settled on the opposite—or western bank.

The main work of the first half of the season was near Kafr Ammar, about 37 miles south of Cairo. There, a widespread cemetery of the earliest dynasties was found, continuing also on a lesser scale down to Roman times. As a distinctive name is required for the early remains, which are the more important, this volume is named from the nearest village Kafr Tarkhān: while the later remains after the 1st or 11th dynasty will be named from the more general name of Kafr Ammar, the railway-station at a little distance. This is somewhat like naming Draḥ abul negga for the early material at Thebes, and Qurneh for the later material in general. At Tarkhan we had seven at work altogether. With me were Mr. Mackay, Mr. Engelbach, and Mr. Elverson recording, with my wife drawing, and, during part of the time, valuable help was given by Mr. Lawrence, before resuming his work at Carchemish. At about a quarter of a mile away, Mr. Wainwright was working the southern end of the site. We were here from January 13 to February 25, when I went to Heliopolis. There I worked till April 18 assisted by Mr. Engelbach, while Mr. Mackay was working at Memphis.

The present volume deals only with the early remains at Tarkhan, of the 1st dynasty and shortly before, with a few later illustrations which are linked with the earlier. The account of the work at Mem-

phis is also included. The second volume of the year, "Heliopolis I, Kafr Ammar, and Shurafeh" will deal with the remains from the 11th dynasty onward at Kafr Ammar, and the whole work at Heliopolis and Shurafeh.

CHAPTER I

THE DATING OF THE GRAVES

2. WHILE the excavations at Tarkhan were going on, it was evident that we had to do with a cemetery which started shortly before the 1st dynasty, and lasted through that dynasty in continual use. The main material for comparison was therefore that from the Royal Tombs of Abydos, which are precisely dated. For the earlier part of the period the continual changes of degradation in the wavy-handled jars—or rather cylinders, as they all were at this period—gives a sequence which is of some value. Thus it was evident that we could not well record such a cemetery upon the old notation of the prehistoric *corpus*, which was established in *Naqada*, and amplified by additions from many subsequent excavations. That *corpus* only included the earlier part of our present types; and it was not at all full for those, as it was derived from a cemetery which was mainly of much earlier periods. The present cemetery apparently only started at the northern migration of the dynastic conquerors from Upper Egypt; and it represents therefore the dying out of the prehistoric civilisation, and the growth of the early dynastic system, which lasted on to the 11th dynasty, and was not replaced by anything different till the rise of the 18th dynasty. In order, therefore, to deal effectively with this period it is needful to regard it apart from the prehistoric, and to treat it as the earlier section of the dynastic history.

3. The prehistoric *corpus* of types of pottery and stone forms was not applicable to such a scope; most of the old types had become extinct, the majority of

forms were new. It is therefore necessary to form a new *corpus* of types for this age; and, I may say, the needs of systematic treatment will probably be met eventually by the following series of *corpus* types:

- Prehistoric to mid 1st dynasty (*Naqada*, etc.).
- Dynasties 0 to xi (here).
- " vii to xvii.
- " xiii to xxii.
- " xx to xxx.
- Dynasty xxvi to 300 A.D.
- " 200 A.D. to 800 A.D.

The time-range of each *corpus* must overlap those before and after it, in order to show the earliest growth and the latest degradation of the types. Owing to the very different characters of the forms in various periods it would be impossible to keep the same notation for a particular type through all the series; hence the notation of each *corpus* must be independent of that used in the others. The one general principle in all cases must be that of beginning with the most open forms, such as flat plates, and proceeding to the most closed forms, such as bottles.

4. In the present treatment of the material, therefore, we have to start with a fresh *corpus*, and an entire re-numbering of all types, whether they have appeared before, or no. The old prehistoric *corpus* was actually used during the course of the excavations, largely supplemented by additional forms. This caused some difficulty when it had to be used apart by four recorders, and many revisions of it were needed during the work. The whole of these stages have now been passed, and a consistent new *corpus* of the early dynasties has been formed for pottery, and another for stone types, with due regard to the forms that will still have to be inserted in order to carry it on to the close of the Old Kingdom. Every designation of forms in this volume is entirely upon the new *corpus* here published, except in the Conversion Table (pl. lxviii) where such old types as survived are equated with the new numbering. The old distinctions, which are so prominent in the prehistoric age, of Polished, Black-topped, Decorated, Wavy-handled, Rough, and Late pottery were scarcely traceable in the dynastic age, and no distinctive forms belong to different materials. Hence the class letters, such as P, B, D, W, R, and L—though always required for the prehistoric *corpus*—are no longer of use in this age, and all forms are classed into one uniform series from 1 to 99. For

general reference in future, where not dealing with one single age and *corpus*, it may be requisite to designate each *corpus* by a letter prefixed to the type number, so as to distinguish to which *corpus* reference is being made. I would suggest for such a purpose, to prefix O for the present *corpus* of the Old Kingdom, M for the Middle Kingdom *corpus*, E for the Empire, T for the Transition xx-xxx dynasties, G for the Greek, and X for the Christian period.

5. We may now note the stages of the present classification of POTTERY.

1st. All types of cylinder jars (descended from the older wavy-handled jars) were noted in their groups as found together in each grave. From these groups it was seen that—though the continuous degradation of the decoration was evident—the various types had been many of them in use at the same time. There were, however, some distinct breaks in the usage of the forms. Types 46 *b* to *p* were generally mixed, as also were the later types 47 *p* to 49 *l*; while the intermediate types 46 *r* to 47 *m* were linked more often to the later than to the earlier division. Broadly speaking, the wave decoration, 46, held together; while the jabbed patterns, 47, ran down into, and mixed with, the cord patterns, 48, and the line patterns, 49. The plain types, 50, also came into use along with the cord pattern, but were more generally alone.

2nd. Having thus some distinctive groups, the order of which was certain, the other pottery associated with each of these groups was set out, in order to see which types belong only to one or other group. From these restricted types the other graves not containing cylinder jars were then added to their contemporary groups.

3rd. The great jars, type 76, were next compared with those found in the Royal Tombs of the 1st dynasty, which show a continuous decline in size and detail from dynasty 0 down to the end of dynasty ii. Thus all graves containing these were classed in groups according to the style of this pottery.

4th. On reviewing the results, it appeared that it was useless to try to distinguish single reigns in the dating of the graves. A clear distinction could, however, be seen between the grand style of the reigns of Narmer, Aha and Zer, the feebler work of the end of Zer and of Zet, the coarser but abundant products of Merneit, Den and Azab, and the decadent style of Semerkhet and Qa. Thus four periods are apparent in the 1st dynasty.

5th. It therefore seemed best to continue the system of sequence dating numbers on through the early dynasties, as a convenient notation. Taking the materials set out and discussed in *Abydos I*, from the pottery sequence dates, the Royal Tombs, the great private tombs M 1 to 26, and the levels of the town deposits, the following scale of relations of these various dates was adopted.

	s.d.	Cylinder types	Kings	M. tombs	Town level
Dyn. O	77	46, 47			0
	78	48, 49	Ka Ro		20
Dynasty I		49	Nar-mer		
	79	50 <i>a-g</i>	Aha Zer	1, 12, 13, 15	40 50
	80	50 <i>h-o</i>	Zet	18	55
	81	50 <i>p-z</i>	Mer-neit	14, 16, 17, 26	60
		51 <i>d-m</i>	Den Azab	19, 24	70 75
	82	52	Semer-khet Qa	25	80
Dyn. II	83		Ra-neb		
	84		Perabsen		110
	85		Kha-sekhemui		

86 early iiiird dynasty

Henceforward these equivalents will be adopted in this account. The cylinder types are those of the middle of the groups of cylinders found used together. In a grave absolutely dated by the name of Ka were found types 47 *h*, 48 *g*, 49 *l*, and 50; while in a grave dated to Narmer were found 48 *s*, 49 *l*, and 50 *d*.

6th. Having now a large part of the graves dated by the cylinder jars and the great jars, the pottery types of all these graves were set out in their respective periods, 77 to 82. Hence the range of each such type of pottery was shown in a table. All other graves that could be dated by their pottery were then dated.

7th. These results were all tallied with the register-cards, and the cards were then dated and arranged in groups of each period apart.

8th. A final list of all pottery types that could be thus dated by association was then formed, see pl. lix.

9th. All drawings of STONE vases were compared with all the stone vases already dated in *Royal Tombs*, *Abydos I*, *Giseh* and *Rijeh* and other publications.

Every dating comparison was noted on each drawing.

10th. All the datings thus reached for each grave were put together, as the grave-dating resulting from the stone vases.

11th. All the datings by pottery were then compared with those given by the stone vases. Any differences found between these, or between the stone datings, were examined in detail, to see which evidence should yield to the other. Thus a revision of some of the card-datings of the graves was made, and the resultant dating of each grave finally inked on the card.

12th. A list of the stone types, with their ranges of date of each type, was formed from the finally arranged materials, see pl. xlv.

13th. Tables of the contents of the graves were made in accordance with the finally reached dating of the graves, and the *corpus* notation of the pottery and stone, see the registers pls. lx to lxvii.

Such were the various stages in brief, though various modes of handling and searching the record vase by vase, was required in each stage, which need not be described in detail here.

6. It is not claimed that in every case a grave can be certainly fixed to a single sequence period; those graves which were without distinctive pottery may sometimes have an uncertainty of date ranging over two or three periods. This uncertain minority are placed here each in the middle of its range; and it is open to any one to test the closeness of dating of any grave by looking for the range of date of each of the varieties of pottery and stone types in the dating lists of types. Those graves which only contained a single type of pottery and no other objects, or only types which had a very wide range, were of no value as evidence, and would merely impede further researches. These useless records were less than a sixth of the whole, and have not been tabulated.

In the tables of graves, the order and arrangement has been adopted which made the lines most continuous, and therefore easiest to be followed by the eye, leaving those columns which were seldom used to come at the end of the line. The types of pottery and stone are sorted into their principal divisions, so that it may be easy to run the eye down to pick out any type that is sought.

It may be desired to find out what the evidence is, on which the sequence date of any type of pottery or stone rests. In the list of types, the periods in

which it is found, and the number of graves in each period, can be seen. Then on the tables of the burials, that type can be quickly looked for under its periods, and all types associated with it can be noted. The range of date of all these associated types can then be readily found in the tables of types, and hence the degree of certainty of the period of the type in question. In any such question of revision of results it is generally found that several graves hang together, and that to shift the date of one requires others to be shifted with it. Many such revisions have been made in the course of this classification. At first many more graves were credited to period 82, but it was found that there was no serious reason for separating them from period 81, and only half a dozen graves were left, which seemed to go to the close of the 1st dynasty. It is probable that a scanty series of graves did thus continue, as there are other graves which by their forms, modes of burial, use of head-rests, and absence of pottery and stone, seem certainly to belong to the 11th and 12th dynasty. These cannot be classified like the present series, and are dealt with by Mr. Mackay who recorded nearly all of them.

7. Beside thus putting in order all the material from Tarkhan, it seemed highly desirable to render comparable with it the cemetery on the other side of the Nile at Turah, excavated and published by Dr. Hermann Junker (*Denkschriften der Kais. Akad. in Wien*, lvi. *Bericht über die Grabungen . . . auf dem Friedhof in Turah, Winter 1909-1910 . . . Wien 1912*). This account is the most practicable one yet published of a series of graves, and it is useful to unify it with the Tarkhan results of the same age and region.

For this purpose the numbers of the pottery and stone types need to be converted into the numbers used in this *corpus*. In doing this for the pottery types I found about 50 to be added to the 350 we had drawn. These additional types are therefore drawn into this *corpus*, as well as I could manage to do so from the photographs. A photograph is far inferior to a good scale drawing, as the top and base are foreshortened, and the detail of the most important points—the neck and bottom point—are generally lost in skew view and shadow; hence I have only interpreted the photographs as well as I could. The scales were not given with the types, but were recovered from the groups of pottery, so that the drawings here are to the same scale as those from Tarkhan. The stone vases were similarly com-

pared, and fresh types drawn; but no scale is given with any photographs of these, and I had to recover it from chance appearances in the photographs of graves. For the register of whole graves, photographs are generally inferior to a good hand record. No photograph shows the whole contents at once, the levels vary too much; and details in views are often difficult to understand. The experience of practically extracting information from the 46 plates of photographs shows more than ever the advantage of hand drawing for practical purposes. A good drawing is far nearer to a type specimen of pottery than any second specimen that will be found, hence it is abundantly accurate, while it renders detail of the geometrical form which no ordinary photograph will give. The real function of photographs is to give complex artistic detail. As regards registration of graves, the risk of cleaning a grave to be clear for photography, without shifting the contents, is at least as great as the risk of not drawing objects in true place; while as to questions of good faith in registration, the cleaning all the gravel and sand out of the grave before photographing and exposing the objects undisturbed in place, is a process quite as personal as the drawing of the contents.

It may save some confusion if it is stated that Dr. Junker does not attempt to classify his graves into dated order, beyond making comparisons of some hieroglyphs and marks with those already known of the Dynasties 0 and 1. In the "Report on the Human Remains" some graves are assigned to the 12th dynasty, without stating the grounds; and here these will be found classed to the close of the 1st dynasty, by the styles of the pottery and stone vases found in them. The actual graves of the 12th dynasty are entirely different, not having vases, but wooden head-rests.

Many of the Turah graves—like those of Tarkhan—do not yield any distinctive information, and to encumber lists with such material is only a detriment. All the graves which contain a variety of types, of value as associated groups, are here reduced to the same notation, and published in the same way, as those of Tarkhan. Some of the graves of Naga ed Deir, published by Dr. Reisner, have a sufficient variety of pottery or stone vases to date them in the same way; these are therefore also included in our tables. We have then here, on a uniform notation, all of the material of the earliest dynasties which shows the general culture in the north end of the Nile valley, as apart from Abydos

and Naqadeh, which show the southern culture. Our study now must be to trace what we can from this series of remains.

CHAPTER II

CHANGES TRACEABLE IN THE EARLIEST DYNASTIES

8. ONE of the most obvious details of a burial is the direction of the head and face in the grave. As these changed several times, it is a distinctive question in Egyptian burials. In the present period all the burials are contracted with the knees and thighs bent. Reducing the numbers of instances to percentages in each date, the whole of the burials of each date yield, for the head direction—

s.D.	N.	E.	S.	W.
77			67	33
78	56	4	36	4
79	35	0	55	10
80	30	3	57	10
81	43	2	51	4
82	67		33	

In 82 the numbers of directions known (3) are too few for the numbers to have much value. In the other periods (where there are 9, 25, 29, 64, and 51 examples) the results are distinctive; the majority are south, about a third north, and about a twelfth west. The north direction is, however, dominant in 78. Now this is curious, because in other sites the prehistoric are south and the dynastic north. It seems that there was a dominance of dynastic style at first, relapsing into a dominance of earlier style. In the tomb of king Qa (S.D. 82) we have 5 north to 1 south, but that was under strongly dynastic influence. At least we see clearly that the dynastic influence did not increase, but somewhat diminished.

The directions of the face, in percentages, are—

s.D.	N.	E.	S.	W.
77	25	13	..	62
78	4	40	4	52
79	10	31	..	59
80	13	25	..	62
81	6	44	2	48
82	..	33	..	67

We see that the westerly direction is always dominant, the easterly about a third, and a few to the north. There is no sign here of any general tendency

to alteration with time, the custom was stationary in the population.

If now we separate these into male and female bodies, we find for the head direction, the number of burials is—

	N.	E.	S.	W.
Male . . .	13	2	34	1
Female . . .	14	..	15	6

Hence the preponderance of southerly direction is entirely in the male burials, the females being buried equally to north and south.

If we take the face direction—

	N.	E.	S.	W.
Male . . .	4	15	1	31
Female . . .	7	12	..	16

the same is seen, that the preponderance of west facing is male.

There are too few examples to draw conclusions as to the differences between Tarkhan and Turah in each period; but at least in S.D. 78 we find the N. to S. proportion is 6 to 7 at Tarkhan, but 8 to 2 at Turah, so that the early preponderance of north burials that we noticed is due to Turah only.

The preponderance of head and of face directions are clearly connected, and if we reduce them to burials on the right and on the left side we find the number of burials is—

	Males.		Females.		Unknown.			
	R.	L.	R.	L.	Tarkhan.		Turah.	
	R.	L.	R.	L.	R.	L.	R.	L.
77	..	2	..	3	1	2
78	2	7	2	4	1	10
79	..	7	..	6	1	10	..	4
80	1	9	..	16	2	13	2	18
81	4	18	..	8	2	15	1	..
82	..	1	1	1
	<hr/>		<hr/>		<hr/>		<hr/>	
	7	44	2	33	7	45	4	32

Here in each period there are a few burials on the right side, but the regular rule is burial on the left. There is no tendency to change from one side to the other; but on the whole the males have more exceptions from the left position than the females.

The whole conclusion must be that *only about 1 in 9 was buried on the right side*; that *there was no progressive change in direction* at Tarkhan, though there is a slight change from north to south at Turah; and that the south being nearly twice as usual as the north was due to a preponderance in the male burials only.

9. The next question is the size of the graves,

which gives a general indication of the resources of the people. The median size is at

s.D.	Tarkhan.	Turah.
77	35 × 69	
78	41 × 70	33 × 44
79	40 × 70	38 × 60
80	40 × 63	35 × 58
81	36 × 61	40? × 88?
82	28 × 53	

The last entry in each column is of only four or five examples, too few to give a true average. At Tarkhan there is a slight rise to 78, and then a steady decline; at Turah the maximum is at 79. This is reasonable as it implies that at Tarkhan a decline set in under Mena, owing to the foundation of Memphis, which drew away the richer people; while Turah opposite Memphis was richest during the first century of the new capital.

10. The proportion of male to female burials noted shows curious variations. It can only be stated for Tarkhan, as there are no general records of sex at Turah—

s.D.	Male.	Female.
77	3	3
78	10	2
79	7	7
80	10	16
81	25	9

The fluctuation shows no consistency, and we could hardly draw any conclusion from it. Possibly as 80 was the richest and most luxurious age (Zet and Den), so female burials then received more attention. It must be remembered that we are only dealing with the burials which had enough offerings in them to yield a date; the actual number of bodies interred may have been equally male and female, but we can only note here what we can date by the presence of a variety of offerings.

11. Burials were frequently without coffins, and, in other instances, the coffins had often been destroyed or decayed, so there are not nearly so many coffins to note as the number of burials dealt with above. The types of coffin recorded are as follows—

s.D.	Wood coffin.	Tray.	Basket.	Pottery.
77	11	..	1	
78	17	2	..	
79	8	5	3	
80	12	9	5	
81	19	7	6	3
82	1	..	1	

The proportions between these show that the tray with shallow sides was coming more into use, and also the basket, during the first dynasty. As to the earliest use of the basket, the reed-case must be dated to 77 or 78 by the pottery found with it; but the baskets of 79 are not in closely dated graves, and it would be quite as likely that they might be of s.D. 80, so the basket coffin cannot be safely fixed before that.

The comparative poverty of Turah is seen not only in the smaller size of the graves in each period, but in the scarcity of wood coffins.

s.D.	Mud.	Wood.	Pot.
78	13	1	1
79	..	1	..
80	..	4	1

Before the founding of Memphis they are nearly all of mere mud; but by the middle of the first dynasty some wood was occasionally used.

Not only was the tray growing in favour, but the coffin was being diminished in height, assimilating it to the tray. The average height of the coffin was—

s.D.	Inches.
77	24
78	20
79	16
80	13
81	14

The whole coffin also diminished in size, the median sizes being—

s.D.	Inches.
77	51 × 23
78	52 × 25
79	45 × 20
80	52 × 23
81	39 × 20

The diminution was checked in 80 because the trays came more into use, which needed less wood, and would not hold the body in so well as a coffin; but even the use of the tray did not check the diminution in the last period.

12. Looking at the funeral furniture, we see that the burial of beds was increasing up to the age of luxury in s.D. 80. The numbers are—

s.D.	bed
77	1
78	1
79	6
80	10
81	9
82	1

The use of copper tools seems more general earlier ; but as they would be among the main objects to be robbed from the graves, these numbers may be affected by the part of the grave in which they were placed.

S.D. 77	3 tools
78	6
79	1
80	1
81	2
82	0

Summary

13. From these various classes of remains, which are so numerous that they can give statistical results, we can now draw some conclusions.

In general, there was no progressive change in the direction of burial, head to north or to south, but the excess to the south were males. There was no change in the attitude, all were contracted ; and the same proportion, of about 1 on the right side to 8 on the left, continued throughout.

Two periods of *maxima* may be seen. In S.D. 78, the age of Narmer (Mena) and his immediate predecessors, the sizes of the graves and of the coffins were greatest, and diminished as time went on. Copper tools were then more often buried. We may call this the maximum application of labour and reality.

In S.D. 80, about the time of queen Merneit, the number of wealthy female graves, and the number of burials of beds, were greatest. We may call this the maximum of luxury.

The decline at Tarkhan was probably hastened by the rise of Memphis under Mena ; while Turah, though much poorer, yet benefited by the political change.

CHAPTER III

THE CONTENTS OF THE GRAVES

14. IN giving account of so large a cemetery it is desirable to publish a compact register of the groups of objects found. To describe every grave separately in detail means a callous disregard of students and readers, as such a mass of undigested material cannot be used without a long process of tabulating. That tabulating is best done once for all by those who know the material, and done at once while the details are remembered. Such a tabulation compels a proper mode of registering the pottery and stone forms. It is a mere waste of the material to rely on

small scattered sketches which are not co-ordinated, and which have no connection ; the details of form cannot be seen safely in small figures, and the whole business of comparative treatment and connection of forms is shirked by the observer and thrown upon the reader. It is useless to expect the reader to wade through the connection of hundreds of small drawings repeating the same forms many times ; and such a shape of publication would be the virtual death of the material.

The only permanent system of registration is by having a full *corpus* of all the forms arranged and numbered ; and then to record every type of pottery and stone by the *corpus* numbers. Such a system was started in publishing the first known great prehistoric cemetery, that of Naqadeh. It has been carried on in the publications of *El Amrah*, *Diospolis Parva*, *the Predynastic Cemetery of El Mahasna*, *the Labyrinth and Gerzeh*, etc. To that prehistoric *corpus* we need now to add a *corpus* of the early historic age here, in order to deal with the new material.

A movement in this direction has been made in the useful publication by Dr. Junker of his work at Turah, and it might seem a pity to relay such a foundation. Unfortunately his *corpus* only includes a third of the required forms, its order is not in uniform progression (from the most open to the most closed types), and the photographs are not to any uniform scale, and are indistinct in parts so that the forms are uncertain. It seems needful therefore, in view of future work, to lay out a uniform and full *corpus* of drawings.

The register of Dr. Junker is so valuable for comparison with our results, that it is here extracted, with the numbers all converted to the *corpus* numbers here used, both for pottery and stone. Of course neither in our own results, nor in his, is it of any use to publish records which mean nothing ; a single common pot in a grave is valueless as a record, or even two very common contemporary forms if repeatedly stated ; only groups are of use which serve to connect the historical range of the forms, or to connect them with other objects found in the same grave. Useless records are a great evil ; if published they waste the time of every student and obscure the other records with which they are mixed. When the material in a group is insufficient to give any effective result, it is only a detriment to encumber publication by such useless records. In no science is the result of every inconclusive experiment published, but only those which can have some result.

The form of register here adopted shows all the matters which are wanted for comparative reference. The explanation of each column is given at the base of the first page, pl. lx. The fullest columns are put to the left, so that the lines can be traced most easily. By classing the pottery and stone types approximately in columns, it is easy to run through all the eight sheets of registers in less than a minute, in order to note every occurrence of any particular type. The sequence date given with each form of the *corpus* will show more closely how far the register need be consulted.

On pl. lxxvii are the more important of the groups of the Naga ed Deir Cemetery, which correspond in date to the present work. These are recorded here from Dr. Reisner's publication, so far as the skew views of the photographs enable the types to be distinguished; many vases cannot be typed at all, especially the bowls. It is much to be hoped that adequate drawings, on the standard scale of one-sixth, will be published of all these large and important groups, so far as the *corpus* here will not suffice for their registration.

15. We now proceed to supplement the registered details by a description of the exceptional objects and details of the graves of Tarkhan, in the same order as the register. It may be taken as a general statement that every burial on this register was contracted, with the knees sharply bent, the thighs bent square to the body or more acutely, the elbows bent at right angles or more acutely, and the hands usually before the face. The graves marked L were lined with brickwork, with a decided batter, smoothly plastered with mud, but not whitewashed. Otherwise the graves were merely cut in the gravel roughly, square or oval, marked S and O. The roofing, if traceable, was of sticks laid across, to support matting now perished. Probably most of the graves were not roofed at all; in no case was any arching or corbelling seen, though the sides were often not at all weathered down. Only three stairways were found, described under Burials; and only twice were there separate chambers for the offerings, in grave 158 (pl. ii) and mastaba 1060 (pl. xviii). As most of the graves had been plundered, the body was usually broken up or missing altogether; and though the soil was preservative of woody fibre, the bones were usually fragile. The general scattering of the pottery prevents its position being of importance in most cases.

16. SEQUENCE DATE 77. Grave 81. Body per-

fect, but probably robbed, as broken bits of alabaster vase were scattered near the face. Circular slate before arms (xxix, 9); 2 shell armlets on left forearm; bag of malachite and galena between right hand and face. Beads on left forearm and wrist, and right wrist, see section on Beads.

Grave 86. Ivory spoon (xii, 2; xiii, 13), slate dish, two alabaster vases, together inside coffin in front of feet. Pottery 46*f* in front of coffin head, 54*s* behind coffin (see xiv, 50; xxix, 10).

Grave 104. Turtle palette (i, 11; xxix, 8) on top of a cylinder jar 46*f*; nothing else left in grave.

Grave 141. Pottery all inside coffin except two 46*p* at back of coffin.

Grave 144. Along front, east, of coffin, three carved legs and one beam of bed, 70 × 32, other beam outside of feet. Wooden tray and dipper (xi, 25, 27; xii, 8, 9), along front of coffin.

Grave 315. Body gone. Bull's horn in middle, gazelle skull in corner. Wave-pattern slate jar, i, 4; cylinder with name of king KA (?) (xxxix, 66,) see 78, grave 261.

Grave 466. Rectangular basket coffin of rushes; only one pot, 60*d*, may be of this age or later. Head S, face E.

Grave 527. Wooden table board, much like xi, 23, but with two ridges across it instead of feet. All nine jars contained ash. No body.

Grave 804. Twenty cylinder jars, all containing mud.

Grave 1006. Finely built walls with batter, coated with an inch of plaster with straw. Lined round with matting. Bricks 9.2 × 4.5 × 2.7 all laid stretchers, courses breaking joint.

Grave 1015. Copper adzes and chisel behind head (v, 26-8; vi, 7-9).

Grave 1037. Sloping sides plastered, but no brick-work. Lined with reed mat. Flint knife (vii, 5).

Grave 1051. Five hardwood arrow-heads (ix, 14-18; x, 7), dated by one pot 46*f*, nothing else in grave.

Grave 1062. Long spoon (ivory ?), remains of slate palette of double bird type.

Grave 1063. Fish palette (i, 9; xxix, 28) dated by cylinder jars 46*d, f, k*.

17. SEQUENCE DATE 78. Grave 7. Plaster still soft when pottery was put in. Pole roof covered with matting. Two-stroke mark on several cylinder jars. Copper axe (vi, 6) outside south end of coffin, close to wall. Fifteen cylinder jars on east of coffin, big jars on north of coffin.

Grave 8. Body closely contracted in a square case made of matting. Three cylinders and big jar west of case, one cylinder to south.

Grave 9. Wood coffin remains with mat lining. Wood 7 thick, cross bars below.

Grave 16. Copper bowl (vii, 14) at south end of grave behind stacks of pottery. Twenty-eight cylinder jars. Square slate at S.W. corner, (xxix, 4).

Grave 20. Large and well made, mud plastered, with flat ledge around. Remains of wood coffin, and wooden dagger lying on ledge at east (i, 1; xi, 20). Bull's horn on ledge at west. On several jars the fore-part or hind-part of a zebra, exquisitely drawn in ink, see iii, 6, in which these drawings are enlarged one-eighth.

Grave 27. The scarab case (iii, 4; xiv, 19) was found loose in the coffin; the pottery was outside the coffin at the north end. No trace of body.

Grave 37. Bit of a thin adze (iv, 12) outside coffin at north end. Bones of calf and birds outside at south end. Pottery along west side.

Grave 39. An adult, head S. face E., and a child before it, head S. face W., both contracted. A copper rod near the south end, calf's leg-bones at N.E. corner.

Grave 42. See pl. xxiii. Brick-lined, bricks $9 \times 4\frac{1}{2} \times 3$. Mud-plastered; lined with matting while soft; beam 6 inches thick, from end to end, to support roofing. Large jars at south, in rope-nets, full of scented fat. Lid of coffin thrown off on west. Bones of calf on west. A few small green beads. Skull and vertebrae loose outside coffin. Two alabaster dishes, not in register.

Grave 43. A beam from end to end of grave, for roofing. Ends broken out of coffin.

Grave 197. Rare jars 95 *m p*, one on each side of head, four cylinder jars full of ashes, at head end, one at feet. Malachite under the arms.

Grave 260. Limestone dish 17 *k*, alabaster vase 71 *v*, slate xxix, 7, all in front of body in coffin. Pottery outside coffin at S.W., 59 *p* at N.E., 60 *d* at S.E.

Grave 261. This is an important dated grave (see xxi) having the name of king KA of dynasty 0 on one of the jars (i, 6; xxxi, 67). An alabaster vase, 70 *d*, has traces of an erased inscription on it which might possibly be of the same king. A few beads (xiv, 51) were found loose. There was no trace of body or coffin. The grave 315, classed under 77, appears also to bear the name of KA on a jar; and though the pottery would make 77 a rather more

likely date, yet it is quite possible that it is really of 78 as grave 261.

Grave 412. This was a fine grave containing the name Tahuti-mer (xxxii, 71), shown in two views (xxi), one from each end. The views are placed side by side, with some jars marked A,B,C, so that the connection of the views can be traced. The pit is cut in gravel, mud-plastered, 125×61 inches, and the wall 60 inches deep; around it is a flat ledge 32 inches below the ground, 16 wide on W., 18 on N., 22 on E., and 21 on S. There were parts of the thighs and the pelvis still in position, without any trace of coffin, scarcely sufficient to indicate the direction of the body. An adze (v, 29; vi, 15) and a copper bowl (vii, 15) were found to the N.E. of the place of the body. As the grave was close to 414 it was doubtless of the age of king Nar-mer-tha.

Grave 414. This grave was one of the largest, and the most important historically as it contained the large jar of king Nar-mer (xxxii, 68), and the sealings with his name and the variant Nar-mer-tha (ii, 1-4). The view of the confused pile of pottery is given in xxi. The pit was cut in the gravel, brick-lined and mud-plastered; bricks laid as stretchers, roughly; the plaster mixed with a little straw. Pit $140 \times 66\frac{1}{2}$, depth of wall 71, the ledge around it 19 on N., 21 E., $17\frac{1}{2}$ S., 24 W. See the grave 415 under S.D. 80.

Grave 901 had a square basket of reed for a coffin: well dated by pottery 48 *s* and 49 *d*, and there was also 60 *d*. Head N. and face E.

Grave 1023. The ivory spoon (xii, 6; xiii, 1-6), model copper tools (v, 16-24), and broken alabaster vases, were all loose in the earth filling, as left by the plunderers. Twenty cylinder jars about the S. end, with a row of larger jars along the S.

18. SEQUENCE DATE 79. Grave 3. Roofing poles complete, see xxiii. Coffin 32×25 head N., face E. Female, in clothing. Lid not fitting coffin, but made of two boards tied together, 40 inches long. A piece of old house-timber (ix, 4) was used in making the coffin, 3 pots, 60 *b*, outside coffin on N., and one on S. This does not define the date between 77 and 81.

Grave 54. A well-preserved bedstead stood in the grave, with the contracted body lying across it, the hips and shins upon one side-pole, and the feet out beyond the bed. There was no trace of disturbance of the body, which was quite intact with the knees drawn high up and the hands before the face. Probably the body had been bundled in cloth, which

has since become decayed, and the bundle was laid carelessly across the bed. A round slate (xxix, 17) was broken in two, half under the head, half behind the head; this was probably done, therefore, before burial. The form of the bed-frame is shown by the corner (viii, 3). A basket stood on the bed-pole behind the pelvis. The jars contained ashes. On them were two pot-marks (xxxii, 84, 110).

Grave 175 was cleared by Mr. Engelbach, and he describes it as follows: The grave contained two coffins side by side. The coffin on the left was of the common early 1st dynasty form, its dimensions being 53 × 18 inches and 15 inches deep. The sides of the coffin were of one plank each, but the ends were of two planks one above the other (which is the more usual type). Two pieces of wood, notched at each end and shaped somewhat like yokes, were placed upright, one against each side of the coffin. Their ends were buried a few inches below the level of the bottom of the coffin. It is not certain what their use was, but it may have been that the coffin was rather weak, so that these were placed outside to keep the sides tightly together so that the ends could not fall out. The body was wrapped in a large quantity of cloth which was very much stained, and there appears to have been matting above and below it. The body was laid on its back and at full length except that the tibiae were bent up under the femora so that the feet were nearly under the hips. This position is unusual, but has been observed before at Tarkhan.

The other coffin was hollowed out of a single piece of wood, and was 43½ × 11¼ inches and 10½ inches deep, externally (see pl. xxiv). The thickness of the wood was about ¾ inch at the sides and 1½ inches at the ends, and the wood was considerably warped. Underneath the coffin there were two cross-pieces 11¼ × 1¼ × 1½ inches pegged on to make a stand for it. The cover of the coffin had a small boss at one end projecting about 2 inches with a width of 1½ inches which was meant for a handle, and there were a pair of holes at each end of the coffin so that the lid could be tied down by passing a string through the holes and over the handles.

The board for the cover was originally not wide enough to go on the coffin, so two strips of wood were pegged on by tenons at either side so as to give the necessary width, the whole being reinforced by two cross-pieces which were fixed on by the usual cross strips. This coffin was probably a clothes-box. The body within it was that of a young adult of about 23 years and was placed in the coffin in a dis-

membered condition, as no bones at all were in their correct places. This is proved from the fact that it is physically impossible to get an adult body into a box of the dimensions given. A likely explanation is that the man was found dead with most of the flesh decomposed and that the bones were buried by his relations. The bones could not have been sunbleached before burial, as the cloth, which appears to have been placed at the bottom of the coffin, was considerably stained. Both the bodies were of the male sex.

Five pots were found with these coffins; four of the type 59*b* at the south of them and one of the type 65*w*, in the large coffin, placed near the knees.

Around the large coffin, with one side resting on the small coffin, were the remains of a large bed 75 inches long. The breadth is not known, as the end-poles are badly broken. The bed is of the type described in pl. ix.

In the S.W. corner of the grave were three large wooden bulls'-legs, 9 inches high, the muscles being raised and the work being very good. The whole tomb-group is now in the Manchester Museum.

Grave 203. Box-coffin cut out of a single block for its sides and bottom (xxiv): the ends were each made of two boards and inserted with halving joint, and at each end a ridge was left on the bottom, to serve for feet.

Grave 278. Woman with four armlets on left forearm; proximal, ivory, slate, slate, horn in two pieces (ii, 13, 16), distal. Beads round neck.

Grave 279. On forearm, horn armlet with copper threading (as ii, 12) and ivory armlet (ii, 6).

Grave 474. The copper spear-head (i, 12; iv, 6) was lying close to the S. end of the grave, and near it the ivory spoon (xiii, 10). Pottery lay by it and at the N. end. Calves' jaw-bones on W. side. There is no trace of later objects mixed in this grave; and the position of the spear-head, close along the end wall, is just where copper implements were found in other graves, and where it is least likely to be left by any plunderer. Hence we must accept the early date of this, although no other such copper spears are known then; it is like the perfectly certain evidence for the prehistoric copper dagger at Naqadeh, and these show how scanty our knowledge is of the weapons which were nearly always robbed from these graves. The pottery dating is not very exact, but more likely to be earlier than later.

19. SEQUENCE DATE 80. Grave 60. The body was destroyed, but had lain on a wooden tray, jointed

in a remarkable manner; see ix, 20. With it were an ivory cylinder jar, 53 *g*, and hair-pin; 3 flint armlets, and 2 slate armlets.

Grave 80. An undisturbed burial with 6 stone vases in a basket, placed upon another basket with 4 vases, close south of the pelvis. A string of serpentine, garnet, carnelian, and other beads. Basalt bowl outside of the baskets.

Grave 137 contained a basket with lid, of egg-cup shape, like Junker's *Sondertyp* 3 in pottery.

Grave 149. Eight flint armlets, four on each arm. Poles and boards over the top covered with matting.

Grave 170. In one coffin two bodies, faces N., heads E. and W.; very prognathous, light-brown hair; see xxii. Skulls and bodies in position, but legs and arms shifted. Copper adze, iv, 5, in front of one body.

Grave 195. Lined with bricks, bonded English bond, nearly 10 × 5 × 3.

Grave 204. Body on tray of reeds, bordered with four branches of wood. Roofing of branches of wood, with a thick layer of reeds.

Grave 230. Undisturbed burial, coffin much decayed. Pottery all round coffin, but double row at N. end.

Grave 415. Roofing of large branches covered with matting. Wooden coffin badly decayed, mat on bottom. Upon the coffin a three-legged stool upside down. In the coffin were two alabaster jars before and behind the head; a slate palette (xxix, 21) before the hands; a cylinder jar with inscription (xxxi, 69), apparently of Nar-mer, behind the back, and three other cylinders at the foot end, containing ashes. Around the neck were strings of amethyst and carnelian beads, the largest in the cemetery (xiv, 53). As to the date of this grave, the cylinder jars, 48 *l*, 49 *l*, would point to S.D. 78, the smooth type, 50, would rather point to S.D. 80, but it was found also in the Nar-mer grave of S.D. 78. Of the stone vases, 14 is indecisive, but 61 and 72 are entirely of S.D. 80 and 81. Thus the evidence of the vases would be mainly for the later date of 80, but the inscription strongly suggests S.D. 78.

Grave 422. Ivory armlet (ii, 6) on forearm.

Grave 538. A bed-frame was placed on the top of the box coffin. A sheep's head lay N. of the coffin end.

Grave 1013. Two alabaster vases in front of arms, 3 pots at feet.

Grave 1060. The great mastaba is fully described in chap. iv. by Mr. Wainwright, who excavated it.

20. SEQUENCE DATE 81. Grave 61. Undisturbed burial upon a bed-frame. Pottery all within the frame. Alabaster 72 *g* behind the head, 14 *b* farther back on corner of frame. Baskets beyond feet. Pottery all behind the body.

Grave 88. An example of close packing of a body in a basket coffin. The femur was 17½ inches long, humerus 12·7 (445 and 324 mm.), a full average size for a man; yet the body was entirely packed into a rounded bundle 27 × 15 inches, put into a basket of 34 × 20 inches. Two alabaster vases, 78 *l*, were in the basket, one beyond the head, the other behind the pelvis.

Grave 89. A complete burial in box coffin 28 inches long. Pottery beyond head and along back of coffin, outside. Limestone dish 12 *d* at the back, and behind pelvis 2 saucers 7 *b*, one inverted on the other; in the lower were pieces of charcoal, and smoke on the upper. This is the earliest example of fire-offering known. Similar bowls of charcoal were found in xith dynasty graves. The teeth were peculiar; though the body was adult (femur 17·8 inches, trunk 30 long), and the wisdom teeth were fully grown, yet the canines were not forward.

Grave 101. A large grave with beam from end to end for roofing. At N. end 37 jars of 59 *h*, sealed with mud, and containing scented fat. Alabaster jars to the N.W., and along E. side with cylinder jars.

Grave 107. Tray formed of poles laid lengthways and across, and matting over them.

Grave 120. Originally covered in with poles and matting. No body; outside one end of coffin a basket and 5 pots, one of 60 *b* type containing a large number of the black desert beetle.

Grave 122. Copper axe, adze, and chisel (iv, 4, 14; v, 25; vi, 3-5) inside N. end of coffin. Bones dragged out, lying E. of coffin with black basalt cylinder jar 60 *f*.

Grave 136. The wooden table and sandal tray (xi, 23, 24; xii, 7, 10) were lying on edge against the western side of the coffin. Twelve pots stood round the north and north-east of the coffin.

Grave 158. This was the only example with offering-chambers, separate, beside the great mastaba 1060. It was cleared by Mr. Engelbach, who describes it as follows:

The tomb had been robbed anciently. The middle chamber, which originally must have been the burial-chamber, was absolutely bare, with the exception of a plain, rectangular slate palette which was fixed in the plaster on the wall at A, pl. ii, no. 21.

The top of the walls of the chambers lay about 40 inches below the surface of the desert. The chambers B and C contained many pots which had been anciently broken. At the S. end of the grave the chambers seem not to have been touched, perhaps because the robbers, having taken any valuables which may have been on the body, broke open the N. chambers, and, observing nothing but pots, assumed that the S. chambers were similarly filled, which proved to be the case.

The chambers D and E were covered with planks laid across the grave about 20 inches and $1\frac{1}{2}$ inch thick. These planks had mortise-holes along their edges, and were probably house-timbers; they are described with plate ix.

The grave appears to have been built as follows: A hole was dug in the desert about 180×70 inches, and 100 inches deep, and a chamber, 70×40 inches, internal measurement, built centrally in it, the walls being $1\frac{1}{2}$ bricks thick (*i.e.* about 14 inches); the spaces which were left at the north and the south were then divided by walls one brick thick (that is, about $9\frac{3}{4}$ inches), which abut on to the main walls. These end chambers were then widened by 5 inches on each side.

The parts F and G are really untouched desert which we removed in digging out the grave.

The inner face of the middle chamber had been plastered with mud, but only the slate palette was left in it.

The chambers contained the following objects:

Chamber B. Pottery, 6 of type 59*b*, 16 of 59*p*; 5 of 81*c*. All bore traces of mud sealing, and most of them contained scented fat.

Chamber C. 3 pots of 59*k*; 10 basket-work mats, which appear to have been stands for pots.

Chamber D. 4 large jars full of ashes, 76*l*, marks xxxi, 83, 131; 7 of 59*k*, marks xxxi, 166-8; 2 of 59*f*; 2 of 59*m*; 1 sandal-tray (vii, 6; xii, 11). Flint knife with handle; right-handed (xi, 26; xii, 1).

Chamber E. 4 dishes of 11*b*; 2 pots with scented fat, 81*c*; 3 pots of 33*k*; 1 dish. Bones of an antelope.

Grave 169. In the floor of the large chamber, N. $90 \times 160 \times 37$ deep, there were two lesser chambers N. 35×52 and N. 42×36 , both 43 deep, separated by a brick wall 6 inches thick. All of the chambers were brick-lined. The lesser chamber was full of two layers of pots, 25 in all; the larger chamber also contained some pots, but was robbed of the body

and valuables. On the side of the chamber was a slate palette stuck in the mud plaster, as in grave 158. The pottery had been put in the chamber while the plaster was soft.

Grave 213. A wooden coffin of the usual kind, with a double row of jars along each side of it. At the end stood a clothes-box containing a small circular slate palette, and the wooden box iii, 2; xi, 22. The lid of the box was pegged on, but on opening it nothing was found inside except the ivory comb (ii, 11; iii, 2) inscribed *ka da*, probably the owner's name. The case seems as if intended to hold a large SA amulet. One of the slate bowls from here is shown in i, 7. The roofing was of two beams of wood from end to end of grave, supporting seven branches laid across the grave.

Grave 231. Wooden coffin. Alabaster cylinder jar before feet, another behind back. In corner behind head, a dish, and in it the inscribed bowl, 24*t*, iii, 1, with the figure of Ptah in his shrine and his name above. This is probably the earliest figure of a god known, excepting the Koptos colossi of Min. The age of it is therefore important; the dates of the allied pottery are S.D. 79-81, 80-81, 77-81; the dates of the stone vases are in five instances, where known elsewhere, all of S.D. 81. It might be questioned if the S.D. 81 types were not more widely spread over later periods; but, on looking at Abydos, such pottery goes to S.D. 79, and there is no trace of such pottery at Beyt Khallaf in the beginning of the iiiird dynasty, nor at Abydos in the iind dynasty. It seems, therefore, certain that this figure of Ptah must be as early as about the reign of Den, ist dynasty.

Grave 269. Arms extended in front, slightly bent, perhaps pulled out by plunderers. Only one horn armet (ii, 12; vi, 14) left on arm, others scattered in grave, 4 of slate, 1 of ivory (Mackay); see limestone and shell armlets, ii, 7, 8. Beads scattered in front of legs, (xiv, 60-1).

Grave 1016. This may be quoted as a complete example of the later graves of the 1000 cemetery. The pit is square, 59×38 , just large enough for a closely contracted body; an alabaster bowl and jars in front of head and knees, three alabasters beyond pelvis, and six pottery jars and bowl beyond feet. The contents of three alabasters and 2 pots are mud, four pots near the feet in the N.W. corner contain ashes of halfa-grass with chips of pottery, and the rest of the vessels are empty. The sides of the grave were lined with mats; under the body lay some

remains of a wooden tray ; the roof was constructed of poles covered with matting, and a mud coating was placed over all.

Grave 1018, like many others, was cut wider in the loose gravel at the surface, and then narrowed in the soft limestone. On the ledge at the side was straw plaiting covered with mud, probably part of a mat spread over the whole roofing ; 1020 had a reed mat on the ledge.

Grave 1034. An interesting example of a multiple burial, see xxii. In the S.W. corner were two contracted skeletons similarly placed, head S, face E, one before the other. Before them, in the S.E. corner, was an oval pottery coffin with a child placed head N, face E. In the N.W. corner were 17 jars in rows, and 3 bowls. On the west of the jars and feet of the adults, were alabaster vases. The pottery jars had the three-stroke mark, like xxxi, 176-8, and a mark like xxxi, 110.

21. UNDATED GRAVES. Grave 17. Adze and flaying-knife (iv, 2 ; v, 15) lay close to south end of grave. Three gaming-rods of ivory (like xiv, 29) and a flint plate (vii, 12) were loose in the filling. No body or pottery left.

Grave 22. Two flaying-knives (iv, 1, 7) and tip of a bow (vii, 1) lay close to the N. end of the grave. The various deposits of copper at the ends of the grave had doubtless been overlooked by the plunderers anciently, and needed a very thorough search to find them. Beads (xiv, 55) loose. No body or pottery.

Grave 96 is an example of close packing. A square basket coffin 28 x 14 fitted into the grave. In it, in a space 26 x 12, was a woman's skeleton with plaits of braided hair, skull 5 inches high, spine 26, leg-bones 15 and 15, total 61 inches high.

Grave 1004. A basket burial, see pl. xxvi. It was placed in a recess, bricked across the mouth. The bricks varied from 9 to 10 inches x 4½ to 5¼ x 3. The recess was 56 long inwards, 40 wide, door 25 wide ; pit leading to it 50 wide tapering to 16, and 30 long. There were no pottery or stone vases by which to date it ; by the head-rest it probably belongs to the iiird dynasty. The head-rest was found in fragments in the pit, outside of the chamber. The basket and body were carried intact to the Cairo Museum.

Grave 1007. The skeleton had been entirely taken to pieces ; see xxii. Not even the finger and toe bones were left together. There were no vases by which to date it.

CHAPTER IV

THE GREAT MASTABA 1060 OF SENAR

By GERALD WAINWRIGHT, B.A.

22. IN the last three weeks of the work at Kafr Tarkhan, I found the large mastaba, no. 1060. Its position is curiously isolated, being far to the south of the main cemetery of contemporary date, and quite separate from the nearest graves of this date, which were on a different mound, lying much nearer the cultivation. It is built of crude brick, and much of it is in splendid preservation, showing remarkably fine and accurate work, though done in so rough a material. Unfortunately the north and south ends are hopelessly weathered away, and do not provide any clue as to the exact length, for in each case the brickwork and also the plaster pavement, which seems to have surrounded the whole, has been reduced to a layer of black dust tapering in thickness to an inch or less. It was therefore impossible to discover how many recesses there originally were on the faces, and so to complete the plan. It is evident, however, that there was not a recess opposite to the chamber, which would have served for the performance of rites ; probably the number was even, as occurs in the ist and iiird dynasty mastabas at Gizeh (*Gizeh and Rifeh*, pls. vi, vii). Some pre-eminence was evidently assigned to a recess which is apparently just to the south of the centre of the mastaba, for while both on the east and west sides, in the recesses which were sufficiently well-preserved, the central panel shows traces of red paint, yet this one alone presents no traces whatever ; possibly a wooden panel stood here. Moreover this recess was floored with wood, which flooring was raised a few inches above the footing, as will be seen in the photograph pl. xv, 1, where it is marked by the arrow, and in the plan pl. xviii. A photograph of this floor is shown, pl. xv, 2. The wood consisted of five planks, the outer of which was 7 x 11 x 72 inches in length, and ran in under the walls of the building. The mastaba was covered all over with a coating of white-painted mud plaster, and was set upon a footing of crude brick 15 inches wide and 7 high. Outside of this was a broad pavement of mud plaster at least 100 inches wide, though no definite edge could be delimited owing to extreme weathering. Upon this stood the fender wall. There was no perceptible batter on the faces of the mastaba, which still remain to a height of 27 inches, leaving little more than a passage between the fender wall and the building. The east face of this wall had a

batter of 5 in 16. There were two sizes of bricks used in the construction. They were on the average $9.1 \times 4.2 \times 2.7$ (variations 8.7 to 9.5, $\times 4.0$ to 4.5, $\times 2.5$ to 3) used for the general building; and the smaller size $5.9 \times 2.7 \times 2.8$ (variations 5.7 to 6.0, $\times 2.5$ to 3, $\times 2.5$ to 3.0) used only for the pilasters.

These pilasters were bonded into the main building. The construction of the walls varied somewhat. Thus the east wall was built of courses of headers and stretchers in the following order:—*h, h, h, s, h, h, h, h, h, s, h, s, h, s*; and the west wall *h, s, h, s, h, h, h*.

All the cross-walls observed were built in regularly recurring courses of one of headers and one of stretchers.

The foundations of the mastaba were of the slightest, a smooth place having been levelled in the clean gravel a little below the desert surface, and directly on this were laid the courses of bricks. At intervals in the brickwork of the walls there was laid a bonding course of reeds and twigs (pl. xvi, 3). Against the inner faces of the east and west masses of brickwork were set a series of small buttresses.

Although we tried the ground most carefully on all four sides of the mastaba, we found no surrounding graves as at Gizeh.

23. The plan of construction, pl. xviii, was simple, and closely resembles that of the 1st dynasty mastabas both at Gizeh (*Gizeh and Rifeh*, pl. vi) and at Naqadeh (de Morgan, *Recherches sur les Origines*, fig. 518) and the small graves of this date at Naga-ed-Dér. (Reisner, *Early Dynastic Cemeteries of Naga-ed-Dér*, i, pl. 76). A central set of chambers was sunk into the rock, and around these, but on the surface of the desert, a thick shell of brickwork was constructed. The interim space was then divided up by a series of cross-walls, though it can hardly be said that they tied the whole together, as they only butted against the outer wall and were not bonded in. The interior of the building was finally filled with sand. These connecting walls did not form chambers in any sense, for they did not rise right through the original body of the mastaba.

24. In the centre of the whole, the main chamber was dug down through gravel to the bed-rock, consisting of marl. At both the north and south ends of this also were dug a pair of small subsidiary chambers for the offerings. A photograph of the north pair is shown on pl. xvi, 2. As in the Gizeh mastaba, the main chamber is deeper than the offering-chambers, the first being 89 inches deep below the ledge, and the others only 69 inches. Here, however, the parallel

chambers lie one beyond the other in each pair, but here they lie side by side, as they do in the grave 158, and also in many of the small tombs, dating to the 1st dynasty, in cemetery 1500 (Reisner, *Early Dynastic Cemeteries of Naga-ed-Dér*, i, pl. 76 and p. 139 *et seqq.*). Curiously enough, although these pairs were so small yet they were strengthened by having a tie-beam built in right across the middle of each, pl. xvi. There was another peculiarity in their construction. Sufficient space does not appear to have been left for them, and hence they run 6 inches into the wall dividing them from the main chamber, pl. xviii. This portion of the wall is carried over them on wooden beams, pl. xvi, 2.

Though there was no connection between these subsidiary chambers themselves and the main one, yet in the upper part of the wall between those, both at the north and south ends, there is a bricked-up doorway, the threshold of which is on a level with the ledge at the top of the chambers. This ledge will be seen in pl. xvi, i, as also the door, which figures in the centre of the top edge of the photograph. The bricking-up bears no signs of being later than the construction of the tomb, and the same bricks are used for this as for the building of the mastaba. It is difficult to surmise the object of these two doorways, and why they should have been bricked up; it can only be remarked that the same feature was also found in the royal tomb of Aha at Naqadeh (*Recherches*, pp. 154, 158).

Of considerable interest are the four false doors, which are shallow depressions less than $\frac{1}{2}$ inch deep, and are found in the central chamber, two being on the north wall and two on the south, pl. xvi, 1. They are painted red, like the panels in the recesses on the outside, which recalls the red recesses in the tombs of Zer and Zet (*R. T.* i, 10, ii, 8).

They appear to have been intended as doors by which the spirit of the deceased could enter his store-chambers from the place of burial, for they are as nearly as possible opposite to the centre of these chambers of offerings, and do not occur at all on the east and west sides where there are no such chambers. All the chambers of the interior were plastered and painted white, while the walls above the ledges were plastered only.

In the south division of the mastaba there was an almost shapeless pit sunk in the gravel, evidently unfinished. When the underlying rock had been reached, a narrow pit was begun which had probably been intended for the chamber. At the south side of

the pit there was an irregular cavernous extension of the excavation. The wall at the north side of this has been built with a smooth face along the edge, though for some reason it is a little thicker on the east side.

In the filling of the mastaba at C were found two pots, pl. xix, nos. 20, 21, and with them a faggot of sticks similar to those used in bonding the courses.

25. A great deal of worked limestone in large slabs had been used, whether as roofing or in some other capacity could not be decided. These stones in their present broken condition ran as large as $18 \times 12 \times 33$ inches in length. In pl. xvi, 1 a few of them will be seen resting both on the ledge and on the floor of the chamber. They were found all through the rubbish with which the tomb was filled when it was discovered. The ledge which runs round the top of the chamber, pls. xix, 1, xvi, 1, no doubt served to carry the roof, just as it did in various of the small tombs of similar construction of the same date, which we found in this cemetery. The stones were only discovered in the central chamber, and formed a feature peculiar to it. That there had been a roof more substantial than one of mere plank and brushwood seems probable from the fact that the plunderers effected their entrance by mining down through the thick brick walls at A pl. xviii (see also the broken edge at the right-hand bottom corner, pl. xvi, 1), and this would have been an unnecessary labour had the roof been easily destructible. If these were roof-stones they would be the earliest stone used for constructional purposes yet known, as they are earlier in date than the granite floor of Den, ist dynasty, which was followed some time later by the stone-built chamber of Kha-sekhemui in the iind dynasty. However, from the numerous large-sized pieces of charcoal also found everywhere in the central chamber, there must have been a great quantity of woodwork used. The only vestige of this still *in situ* is the charred end of a beam still in the hole 3 inches below the level of the roof-ledge. The exact use of this beam is not quite apparent, for if the roofing were of these large blocks of stone, a small beam about 6×6 inches square seems inadequate for any purposes of support. Possibly the chamber may have had a wooden ceiling three inches thick below a heavy stone roof. For such a purpose the beam would have been sufficient.

26. Before leaving the subject of the construction, an examination of a series of measurements will give the length of the cubit used :

Total width . . .	615	$\div 30$	=	20'50 *
E. wall, thick . . .	134	$6\frac{1}{2}$		20'61
E. to W. wall . . .	347	17		20'41
W. wall, thick . . .	134	$6\frac{1}{2}$		20'61
Buttresses, wide . . .	78	$3\frac{3}{4}$		20'80
„ deep . . .	21	1		21'0
Recesses, wide . . .	62	3		20'67
„ deep . . .	21	1		21
„ niche . . .	21	1		21
Chambers :				
Central, long . . .	186	9		20'67 *
„ wide . . .	102	5		20'40 *
„ deep . . .	168	8		21'00
Door, wide . . .	29	$1\frac{1}{2}$		19'33
Smaller, long . . .	81	4		20'25 *
wide . . .	44	2		22'0 * ?
Red recess, high . . .	52	$2\frac{1}{2}$		20'80 *
wide . . .	15	$\frac{3}{4}$		20'0

It is obvious that these data are of very unequal value, as to their accuracy and the certainty of their intention. The mean of the best, marked with a star, is 20'77; or, omitting a very different one marked with a query, 20'44.

The variations in the above table are partly due to the comparative roughness of the material in which the mastaba is built, crude brick covered with mud plaster, which has scaled off in places. It should be remarked that the construction is very good and corresponding features are exactly alike.

27. Although the plunderers had thrown everything about, and had broken the body to pieces, the remains of a rich burial were recovered. The greater part of the tomb furniture had been thrown out into the broken hole in the wall at A; and at B (pl. xviii) were found the bones of an ox, with charcoal, and a few broken potsherds.

Besides great quantities of chips of alabaster, slate, and a few fragments of a breccia dish, there were found :—

17 cylindrical alabaster vases, either perfect or restorable. Types 53 *k*, 54 *l*, *n*, *p*, *r*, *v*, *w*, 62 *n*, *u*.

7 dishes and bowls. Types 8 *g*, 9 *h*, *r*, *y*, 21 *g*, 29 *h*, *j*.

1 small quartz bowl $2\frac{3}{8}$ inches diameter, pl. xvi, 5.

1 unornamented oblong slate palette $5 \times 3\frac{1}{4}$ inches, without a hole for suspension, xxix, 19.

3 tall ivory draughtsmen, pl. xix, 2.

1 flat dome-shaped ivory draughtsman, pl. xix, 3.

1 copper chisel, pl. xix, 4.

Remains of an adze, probably like v, 28.

Various scraps of copper.

Several score of flints. Types xix, 5, 6.

1 small globular flint, $\frac{5}{8}$ inch diameter.

1 box of crude mud, pl. xvii, 1, 2, and the remains of others.

A black ink graffito on one of the pieces of prepared stone, pl. xvi, 6.

Several thick pads of linen of various qualities.

Almost the only remains of pottery found in the central chamber were the pieces of two curious vases of un-Egyptian appearance (pls. xvi, 1, xix, 24). All the rest was stored in the four offering-chambers, in which there was nothing else besides pots. The types are drawn on pls. xix, xx, while the potmarks will be found on pl. xxx. The clay caps on the jars were mostly plain, but such as had sealings are drawn on pl. xxx.

28. We compared the various shapes of the pottery with the dated examples published in *The Royal Tombs I*, pls. xxxix to xliii, and *Abydos I*, pls. xxxvi to xli and p. 21, and the known types are found to fall clearly into reigns of the middle of the 1st dynasty; they thus serve to date the mastaba very closely. The results are here tabulated, the numbers referring to the drawings on pls. xix, xx. As nos. 8, 9, 13, 15, 21, 22, 23, 24, 28 do not occur in these dated groups, and 10 has no date, these are of no use for dating purposes; 34 being so very uneven in its shape cannot be accurately fixed to any type. The 19 dateable types group themselves as follows:—

Reigns.	Types of Pots.					Total.	Sundries.
Mena } Narmer }	. 14	16				2	
Aha } Zer }	. 18	19	25	26	30	35	6
Zet .	.						6
Merneit .	. 7	11	20	31	32	36	6
Den .	. 12						1
Azab .	. 17						1
Semerkhet } Qa }	. 27						1
						—	
						17	2

Here it appears that, out of a total of 19 dateable types, 13 fall between Zer and Merneit. The central point here is Zet, to which the mastaba should probably be placed, although as it happens there is no vase which is datable to his reign. This no doubt arises from the fact that we have very little material of his from which to date. Hence by the pottery

only which the mastaba contained, it dates itself to the reign of Zet.

After the pottery we next turn to the stone vases, the drawings of which had been made by another hand, that of Mrs. Petrie, and which I had not used. Prof. Petrie worked out their sequence-dates, and arrived at the following results.

S.D. 79	1.
80	10.
81	3.

On referring to the comparative table of sequence-dates and kings (sect. 5) we find that S.D. 79 corresponds to Mena and Zer, and S.D. 80 corresponds to Zet; S.D. 81, which is now added to this old list, corresponds to Merneit, Den, and Azab. It is here seen that out of 13 types of stone vases 10 fall under S.D. 80, *i.e.* under Zet, to which reign the mastaba had already been assigned by the pottery.

Thus the two classes of objects are found to be in full agreement as to the date to be given to the burial, and this result is the more satisfactory in that it was arrived at independently from two independent but collateral sources, and by two people working independently of each other.

These results of dating by pottery and stone-vase shapes agree completely with the other evidences of date, as follows:—

1. General resemblance.
 - a. to the mastabas of the early part of dyn. i, *i.e.* Aha and Zet.
 - b. to the small graves of dyn. i.
2. Resemblance of the red-painted recesses to those of Zer and Zet.
3. Resemblance of the system of construction to the technique of the wooden construction found in the tombs of Zer and Zet, on which it appears to be based.
4. Resemblance of the actual construction both in this technique and material to the tomb of Merneit.
5. Actual dating by pottery to Zet.
6. Actual dating by stone vases to Zet.

Hence all the evidences that can be collected converge on the same point, which is somewhere in the first part of the 1st dynasty, and of this period more particularly that part between Zer and Merneit; therefore about the reign of Zet, which lies between these two.

29. *Description of Plates.* Pl. xviii, the plan of the mastaba, which has been treated already.

Pl. xix, 1, the E. to W. section of the central chamber showing the N. wall, which will be found in photograph on pl. xvi, 1.

Nos. 2 and 3 are the ivory draughtsmen. There were three tall ones and one flat-domed one. Two of them are seen lying in the group, pl. xv, 3.

One of the copper chisels was of the thick, powerful kind with a narrow blade, xix, 4. In this specimen the edge is rather less than $\frac{1}{5}$ inch wide, and, as will be seen from the side-view, the chisel is rather thicker than it is wide. The ends of the blade splay out a little on either side. The adze, of which only a few fragments remained, had been of the thin wide type like pl. v, 28. Dr. Tuck, of Univ. Coll., London, kindly analysed samples from this chisel, with a special view to ascertaining the presence or absence of tin. Unfortunately he was too busy to undertake a full quantitative analysis, but reports the following:—

“The enclosed sample contains copper coated with basic carbonate of copper. There is a fairly large amount of silica present, doubtless in the outside layer of carbonate. There may be some tin, but only a very small trace.”

This chisel then was made of copper, and, if it has been hardened in any way, tin was not the means by which it was done.

The flints all belonged to one of the two types here figured, nos. 5 and 6. They were delicately and well made for their kind.

The pottery is figured on pls. xix, xx, and little remains to be said of it. Its value for dating purposes has been treated in sect. 28, and the comparison of its types to those of other times will be made in sections 33, 34. One of the first things to strike an observer is that the separate clays, which were so distinctive of the various classes of pottery in the pre-dynastic ages, can no longer be distinguished. The various qualities are by this time merged into a single substance, which slightly resembles now one and now the other, but in every guise it is quite different to the older classes. The same may be said of the red polish. The burnishing is done carelessly, no attempt being made to obtain an even surface, but a comparatively few irregular rubs are deemed sufficient. This technique seems to confine itself to such shapes as 7 and 17. The body of 7 is not unlike the old R pottery. On the outside it has been very roughly made, merely scraped with a stick or other instrument; 15 and 16 are nicely polished, with the dullish, hard polish of

the Old Kingdom pottery, and not like the bright polishing of that of the pre-dynastic ages. Nos. 25, 26, 27, 29 appear to have been painted red, and the surface has been merely smoothed down with a polisher rather than burnished. This process produces a fine, smooth, hard surface. Nos. 8, 9, 10, 11, 12, 13, 14, 18, 19, 20, 28, 34 have all been red-painted without having been polished; 21, 22, 23, 30 are all unpainted, as are 32, 33, 35, and 36. This last group was made of a pottery peculiar to itself, of a lighter colour than the other classes; it has a good hard body, but of a somewhat rough surface; 37 was of this pottery, but with some facing wash. Many of the vases now appear to have been made on the slow-wheel, for the bases of them show marks of having been cut off the original lump of clay from which they have been turned, whereas in the pre-dynastic pottery no such signs are visible. The slow-wheel, however, has not ousted the hand-made pottery, for many specimens are still made by this means, notably the large pots 25, 26, 27, 28, 29, 30, 31. The semi-circular pattern on 25 has been marked on by the finger. The bands on 26, 27, 28 are rough ridges of clay laid on the surface.

30. No. 24 is a black-painted neck and handle. A handled vase such as this is quite foreign to Egypt, and reminds one of the foreign pottery found under the staircase in the tomb of Zer (*Royal Tombs* II, p. 46, pl. liv; *Abydos* I, pl. viii). It is noteworthy that at Abydos the foreign pottery was found in the tombs of Zer, Den, and Semer-khet (Mersekha) and now it is found once more in another part of the country under the reign of Zet, between the above reigns.

With this piece in the burial-chamber was found the group of fragments figured in pl. xvi, 4. These fragments also appear to be of foreign origin. The body is composed of a thin, hard, pinkish buff clay with grey and dark red specks in it. It has been painted over with a coat of red haematite upon which widely spaced lines in a trellis pattern have been burnished, each by one stroke of the polisher. The uppermost piece shows a portion of the neck, the whole surface of which has been completely polished, without any dull places. This native ware at this period had degenerated into a form wherein the polishing lines did not touch each other, thus producing a streaky, inferior form of polishing; but there is a long distance between this and a pot which is rough surfaced with a few widely spaced polished lines laid on it in a regular trellis pattern, there being $\frac{1}{16}$ inch and more of rough surface between

lines $\frac{1}{16}$ inch wide. In respect of the probable foreign origin of these two vases, it is interesting to observe that these were almost the only scraps of pottery found in the central chamber, the other pieces being 7, 8, 13, 14, 23, and the fragment 25; all the rest of the pottery, numbering many dozens of jars, having been placed in the four store-chambers. These two were thus deposited in the burial-chamber itself along with the owner's most precious valuables, such as his stone vases, chisels of the valuable copper, and ivory draughtsmen. This argues that they and their contents were of much greater value and rarity than were the ordinary jars with their contents, and this would be quite in accord with a foreign origin. They, however, appear not to be Aegean, for Mr. Peet informs me that he knows nothing like them of Mediterranean origin, hence one is referred to Syria, whence (as shown in *The Labyrinth, Gerzeh, and Mazghuneh*, p. 20), there is reason to believe that other pottery was imported at this and earlier times.

31. Pl. xv, 1, shows the east face of the mastaba, and the raised wooden floor of the recess is discernible below the arrow; in no. 2, a view of this recess is given. No. 3 is a view of the group of vases as it was found, and nos. 4 and 5 on this plate and 3 on pl. xviii show a representative group which will give a good idea of the general workmanship. The vases are mostly distinguished by a general clumsiness and thickness of style, though some of the smaller are quite fine and delicate in workmanship. A noticeable feature is that they are entirely made of alabaster, and that the softer stone gypsum—which is so common a little later—does not appear here. Only the very tall vase, pl. xv, 4, and one of the ordinary-sized ones, pl. xvii, 3, are without a cord pattern round the neck. All the others have a raised ridge with diagonal cuts across it, making a rope pattern. They had almost all been blackened by the burning, and most of them contained what appeared to be the charred remains of the scented fat so common at this period. None of them contained the ashes so often found in the alabasters in the small graves of the same date in this cemetery; nor did any of the pottery contain ashes. Hence ashes do not appear to belong to the civilisation represented by that burial which *a priori* might be supposed to be one of the invading race of the ist dynasty. Neither were ashes found in the Gizeh mastaba, nor yet in any of the Royal Tombs at Abydos.

Many of the alabasters were considerably cor-

roded inside, as if by long use with some slightly acid substance. On pls. xxxii to xliiv the alabasters will be found in outline in the positions which their types occupy in the general series.

Pl. xvi, 1, is the view of the central chamber showing the north wall. In the right-hand bottom corner is seen the rough broken side where the plunderers broke in. The two red recesses are clearly visible, as is the hole for the beam above the right-hand one. It is the same view as that represented in the section xix, 1; xvi 2 is a view looking down into the north pair of store-chambers. At the top of the photograph is to be seen the beam carrying the end-wall, which is let into the thickness of the wall. In the middle is the log which has been built into the construction across the chambers. No. 3 shows the bonding course of sticks, which lies between the two arrows. No. 4 is the foreign pottery with the cross-line ornament. No. 5 is the quartz bowl and no. 6 is the ink graffito reading *sn ar*, no doubt the name of the owner of the tomb.

32. Pl. xvii, 1 and 2 show the mud box found in the central chamber. No. 1 shows the bottom, from which it may be gathered that the clay was moulded on a flat coiled mat. No. 2 gives the box itself, from which the near side had been broken out. Sundry other pieces of mud were found, some perhaps originally having formed the cover, but there was nothing that could be supposed to represent a human figure, such as was found in the mud boxes of the xviiith dynasty at Meydum (*Labyrinth, Gerzeh, and Mazghuneh*, pl. xvi). No. 3 shows the rest of the alabasters, which have been treated above.

Pl. xxx shows the clay sealings and the potmarks. *The Sealings* were all of the flat domed type, sometimes moulded over a saucer, and were not the high, conical type moulded over a pot of this shape. They were all of black Nile mud except no. 2, which was of a sandy yellow clay mixed with a little fibre. Four copies of 1 were found. It is evidently a private name, Neb-ka. It cannot be a royal name, as it is neither set in a *srekh*, as are the earliest names, nor yet in a cartouche, as this name appears to be in *Mahasna*, pl. xix, p. 25. It therefore can have no connection with the iird-dynasty king of this name. The whole contents of this mastaba are together now at Cambridge.

33. It has been shown that this mastaba can be dated with considerable accuracy to the reign of Zet; that is to say, to the middle of the ist dynasty, or, in other words, to the period just after the passing of

the old pre-dynastic civilisation, and near the beginning of that civilisation which became so well known under the later dynastic Egyptians. Before leaving the subject it will be well to see whether a study of the representative group of pottery, which the mastaba presents to us, will throw any light on that phase of history.

The pottery is typical of its period, which is one of transition, for it shows affinities both with the old and with the new civilisations. In the discussion there will be need to refer to the pottery of the old pre-dynastic age, and all this will be found duly sequence-dated, for the most part in *Diospolis Parva*, with additions in *The Labyrinth*, *Gerzeh*, and *Mazghuneh*, while the *corpus* of types is in *Naqada and Ballas*, with additions in *El Amrah and Abydos*, and *The Pre-dynastic Cemetery at El Mahasna*. The pottery of the new civilisation, that of the ist dynasty, will be found in *Abydos I*, *Royal Tombs I*, and de Morgan's *Recherches sur les Origines*, ch. iv. The pottery of our mastaba will be found on pls. xix, xx, in the present volume, where thirty specimens are represented. One, however, 24, must be left out of account as it is clearly of un-Egyptian origin; 34 must also be omitted, as its shape is too irregular for a definite determination of its type. This leaves twenty-eight specimens for comparison.

The simplest way of making a comparison between the mastaba types, representative of the later dynastic Egyptian civilisation, and the types of its two predecessors, is to compare each mastaba type firstly with the pre-dynastic shapes, as being the older; and then, if no satisfactory comparison can be found, to compare the type with those of the ist dynasty. In this way, everything in the ist dynasty pottery that can be referred back to the old pre-dynastic civilisation is eliminated, and the residue which does not figure in this set of types must have been imported from elsewhere; that is, it belongs to the new dynastic source.

Tarkhan 1060. pls. xix, xx.	Earlier Naqadeh types.	Later Dynastic types.
7	...	+
8	L 28 b	...
9	L 29 a	...
10	...	<i>Abydos</i> , i, xxviii, 9
11	L 7 d	...
12	P 17	...
13	P 22	...
14	...	<i>Ab.</i> xxviii, 52

Tarkhan 1060. pls. xix, xx.	Earlier Naqadeh types.	Later Dynastic types.	
15	L 78 a	...	
16	L 78 c	...	
17	L 53 a	...	
18	L 53 e	...	
19	...	<i>Ab.</i> xxviii, 19	
20	...	} <i>Ab.</i> vii. 24	
21	...		
22	...		
23	from W 80		
25	...	} <i>Ab.</i> xxxviii, 28	
26	...		} <i>Ab.</i> xxxvi, 45
27	...		
28	...		variant
29	...		<i>Ab.</i> xl, 13
30	...		<i>Ab.</i> xxxvi, 47
31	} { L 38	...	
32		{ L 36 b	...
33		{ L 36 b	...
35	} L 53 a	...	
36			...
	15	13	

Type 7 may be included as dynastic on the parallel of the stone dishes, as no such type is known in the prehistoric times.

The result of this comparison is that, out of 28 pots available for study, 15 are found to represent pre-dynastic shapes, while 13 represent shapes which do not occur before the ist dynasty. Thus a representative group of pottery of the early ist dynasty shows itself—and therefore the civilisation which it represents—to be a mixture of old and new ideas, drawing from two sources which can be readily separated the one from the other. It is therefore a transition stage from the old pre-dynastic civilisation to the later well known historic Egyptian.

On putting the results of this comparison into the form of percentages it is found that

54 % represents the old pre-dynastic civilisation.
46 % " " new dynastic "

This shows the extent to which the civilisation in this reign drew on each of its sources, and it becomes at once clear that the civilisation of the dynastic Egyptian was not an entirely new product ready-made, freshly imported into Egypt, but had already become amalgamated in the first dynasty, at which time the old native culture was the predominant partner, in the pottery-making. Dr.

Reisner has arrived at much the same general conclusion from a comparison of the two ages. (Reisner, *Early Dynastic Cemeteries of Naga-ed-Dér*, I, p. 126 *et seqq.*)

However, these percentages do not give quite a fair comparison, for included in this collection of types are a large number of varieties, which really represent the same original idea. In order, then, to reach a true conception of the parts played by these two sources in the building up of the later historic civilisation, such vases as 12 and 13 should be counted as one, as should 15 and 16, also 20, 21, 22, and 25, 26, 27, 28, 29, 30, and 31, 32, 33, and 35, 36. If we thus expunge material which is not the result of different ideas, but of mere variation, we find that the percentage of native pre-dynastic ideas is even greater, for, of these later ideas,

62.5 % were contributed by the native civilisation.

37.5 % " " " dynastic "

34. It is here seen that in the common class of material, which serves the every-day life of the nation, the old native population is in the ascendancy; but in considering these percentages it must not be forgotten that they are deduced from pottery, which was that portion of the civilisation most in the hands of the lower strata of society, least portable by a new people, and most fixed to the soil. Hence the old ideas would tend to continue, and the new ideas would tend to show themselves less here than in other classes of objects. So while the above ratios may give a very good idea of the large amount of the older civilisation which continued in the country, yet the comparative importance of the two influences in moulding the course of the later civilisation may perhaps be better seen by observing the chief new things which are found as soon as the dynastic civilisation appears. They are also found to be those details of the later Egyptian civilisation, which have been looked upon as its distinguishing marks.

These introductions are :

1. Brick-making, which, if not entirely new, is at any rate vastly extended.
2. Mastabas.
3. Burial without ash-jars.
4. Steles.
5. Bedsteads and pillows.
6. Carpentry on a large scale, and a corresponding increase in
7. Carpenters' tools.
8. Use of copper on a large scale.

9. Sculpture in stone.
10. Writing.
11. Cylinder seals.
12. Artistic ability.
13. Game of draughts.
14. Flax.
15. The slow wheel for potters.

It is these details, and not those of the pre-dynastic culture, which have stamped what we know as the Egyptian civilisation with its peculiar features, and which have shaped its progress during the whole course of its long history. While, on the one hand, the percentages of the common class, *i.e.* pottery, show a predominance in the lowest industry of the old native race, on the other hand the arts show a corresponding predominance of the invading race. In fact, the old pre-dynastic race scarcely seems to have influenced them at all; and although the Egyptian civilisation had long been known to science, yet its pre-dynastic forerunner was never suspected, and when it was discovered its allocation presented the utmost difficulty, as no connections could be obtained between it and its historic successor.

It seems probable, therefore, that the old pre-dynastic people continued to exist as the main body of the nation—the uncultured lower classes—for the most part influenced and not influencing, but supplying the background to the new hybrid civilisation, the most salient features of which were derived from the conquerors. The arts which the pre-dynastic people had possessed quickly fell into disuse before those of the more advanced civilisation of the invaders, which would naturally become the fashionable style. However, the pre-dynastic culture did not entirely pass without leaving its mark, for it probably gave to Egypt its famous power over the hardest stones, and moreover one of the most characteristically Egyptian of arts dates back to this age—the art of glazing.

CHAPTER V

OBJECTS FOUND IN THE CEMETERY

Plates i-xiv

(Reference numbers, top right hand. Grave numbers, bottom left. Sequence-dates, bottom right.)

35. PLATE I. View of the cemetery of Tarkhan from near M on pl. lxix, the hill N on the right and K on the left, the hills F and J in the distance. The hills are of a soft marly limestone, split with joints

and very flaky. Over them are caps of a few feet of gravel and sand.

1. Wooden model dagger, found lying on side of grave 20, S.D. 78. (Univ. Coll. Lond.)

2. Alabaster vase, with wavy handle, grave 53, S.D. 77. Scale 1:4. (Brussels.)

3. Pilgrim bottle of xxiiiird dynasty in string net with cord handle, found in large shaft tomb in middle of eastern spur, map J, pl. lxxiv, xxiiiird dynasty, 1:4. (British Museum.)

4. Hard black limestone vase with wavy band around it; see the complete form in drawing 51c. This is a fine example of the decorative use of the wavy handle developed. Grave 315, S.D. 77, 1:4. (Univ. Coll.)

5. Gazelle slate, grave 84, nothing else with it.

6. Cylinder jar of pottery with name of king Ka. This is closely like the inscribed cylinder found at Abydos in the tomb of king Ka, a predecessor of Mena, see *Abydos* I, iii, 27-32. It has been suggested that these merely refer to any royal *ka*, but on the contrary this inscription is only known from a single one of the royal tombs at Abydos, where it is painted on the cylinders, incised on the pottery (*Ab.* I, iii, 37-8), and engraved on a seal (*Royal Tombs* II, iii, 89). Now here it is found in a grave which cannot be royal, and so it cannot be intended for a royal *ka*; it is clearly just on the same footing as various other names, royal and private, similarly found. The reading of the other signs, *Suten ap*, and *Ha hem ne ka*, I proposed to refer to the personal name of the king, Ap, and that of his wife, Ha. Another proposed reading was that it referred to some product of the south (*res*) and water of the north (*ha*); but this is impossible, as it is never inscribed on water jars, but only on the smallest jars—the cylinders—which are filled with scented fat, or its substitute, mud or ashes. Grave 261, S.D. 78, 1:4. (Univ. Coll.)

7, 8. Two slate bowls from graves 213 and 112; S.D. 81 and 80, 1:3. (Dublin and Bristol.)

9. Slate fish palette, grave 1063, S.D. 77, 1:3.

10. Large hollowed palette, probably derived from the fish form; as nothing was found with it no date can be assigned. Grave 310, 1:3. (Univ. Coll.)

11. Turtle-shaped slate, grave 104, S.D. 77, 1:3. (Cape.)

12. Copper spear-head, grave 474, S.D. 79, 3:5. This weapon is surprising at so early a period, as none have been found until now; yet—as stated in describing the grave—the evidence for its age is un-

questionable (Univ. Coll.). A similar type—though shorter for the purpose of wearing as an amulet—was found with other early amulets, an ivory comb, and a slate palette (*Nagada*, p. 15, lviii, Q. 23), which corroborates the existence of spear-heads of this age. There is much the same case in Babylonia, where only the colossal lance of the king of Kish, and the figures on the war-scene of Enneatum, serve to show how early metal weapons were developed there.

Plate II. 1. Seal-impression in mud of king Nar-mer, naming apparently an enclosed garden or plantation from which some product came (Univ. Coll., etc.). This was found with the three following seals and a large jar bearing the name of Nar-mer (xxx1, 68) in grave 414.

2. Another seal of Nar-mer much like those found at Abydos (*Royal Tombs* II, xiii, 91, 92) but with the *mer* included in the frame, and with the *tha* bird added to it (Univ. Coll., etc.). This is a new point in this name, and the various impressions have been very carefully searched to settle the reading of the sign, in which Prof. Maspero agrees. This must not be supposed to lend any colour to a supposition that Nar-mer is the king Buzau of the iind dynasty: there is not the remotest chance of the objects of Nar-mer belonging to so late a period, and there is no ground whatever for this reading. We might as well attribute an Early English church to Henry VIII. Various misreadings have been started by those who do not know the material, such as the different values proposed for the name of king Zer; these are impossible in view of the piece of his stele which was found and taken by me to the Cairo Museum, where the sign is cut in relief on a large scale. Here we have to deal with a falcon-name, *Nar*, the Qarmut, *Clarias anguillaris*, the sacred fish of Mendes, which is shown alone in the frame on the Abydos sealing. Outside of the frame on that seal is the chisel, *Mer*, which on the Tarkhan sealing is followed by the bird, *tha*, showing a name, *Mertha*. How far this is compatible with the *men* sign, accompanying the name *Nar* on sealing 93 *R.T.* II, xiii, we cannot yet say: that sign suggests, what the position of the name in the succession shows, that Nar-mertha was Mena.

3. Sealing of Nar-mer, the name alternating with what seems intended for a flowering plant.

4. Sealing found with the previous three, and therefore of the same age. It is the seal of the Fayum province; the middle object is a building or shrine (indistinct on the only impression of this

part) with the *bucranion* above it, as shown in all the historical instances of the Fayum shrine (*Labyrinth*, xxix). To the right is the sacred crocodile of the province, Sebek, upon a standard, with ostrich plumes above the back, which were at that time the mark of a divine animal (*R.T.* I, xxix, 86; xxx). At the sides are three other crocodiles, and four below, represented as swimming in the curling waves of the lake. This mode of representing water is not found elsewhere; the usual wavy line can be traced back (*R.T.* II, xix, 148; xvi, 121; xiii, 94) to plain parallel lines, but the curling waves are not shown. (Sealings to Cairo, Manchester, Univ. Coll. Lond., Brussels, New York.)

5-10. Armlets of ivory, limestone, shell and slate, usually found on the left forearm.

11. Ivory comb, found inside the *sa* case, see iii, 2. The name Ka-da seems as if it might be connected with that of the last king of the ist dynasty; if so perhaps the dating should be brought down from S.D. 81 to 82. Of the sixteen types of stone vases and pottery found with it, only two, 59*p*, 63*e*, are yet recognised as extending to 82; the large jar 75*o* seems perhaps later than 75*n*, which is of Merneit's age, and might be later than the form *R.T.* I, xl, 12 belonging to Semer-khet. So it is possible that grave 213, and some others, may be rather later than S.D. 81. (Univ. Coll.)

12-16. Horn armlets. These are not uncommon; they are always made of pieces laced together, often joined with thin strips of copper as in 12, and in vi. 14. The fact that they are never found continuous makes it more likely that they are really turtle-shell. The Nile turtle was certainly common then, as the slates are often carved in the shape of it. (Aberdeen, Ashmolean, Munich.)

17-20. Drawings of a typical early coffin, with the ends rebated in the sides. The bottom is usually of straight boards, sometimes of old house timbers; the sides are of curved boards, fitted along the joint. The joining of the boards is by thin flat dowels. The wood is plane-tree. A full description of all the varieties of jointing coffins in this and the following dynasties, by Mr. Mackay, will appear in the next volume (*Heliopolis I, and Kafr Ammar*) dealing with the later period.

21. Plan of a grave, fully described by Mr. Engelbach in the descriptions of graves.

Pl. iii, 1. Alabaster bowl with figure of Ptah in his shrine, and his name above. The date of the grave, 231, in which this was found is discussed in

the description of graves. It seems unlikely that it is later than S.D. 81, the reign of Den. In any case it is probably the earliest figure of a god that is yet known. See the drawing on pl. xxxvii, grave 231, S.D. 81, 5:4. (Ashmolean.)

2. Wooden case and lid; the form shows that it was intended to hold a large *sa* amulet. There seems to have been some form of handle attached at the lower end of the lid, by the holes and fragments of ties remaining. In it was found only the ivory comb already described. See ii, 11; xi, 22. Grave 213, S.D. 81, 2:3. (Univ. Coll.)

3. Eight armlets of flint, or rather chert; found, four on each arm, in grave 149, S.D. 80, full size. (These and others to Brit. Mus., Oxford P.R., Cambridge Ethn., Dublin, Cape, Reading, Edinburgh, Bristol, Glasgow, Carlsberg.)

4. Alabaster case in the form of a scarab; see drawing xiv, 19. It is hollowed out from the lower end, and has a plug fitting into it, carefully carved with the lines of the horny plates. The case was evidently carried by tying a string to the bottom plug and passing it through the hole between the forelegs on the under-side. Thus the weight of the whole case kept it closed. A similar mode of closing is seen in the pottery horn found at Gerzeh (*Labyrinth and Gerzeh*, vii, 13, p. 23). It must have been intended to hold some object, probably a small beetle. The special interest of it lies in the proof that the scarabaeus was venerated as early as the close of the prehistoric age. The beetles hitherto found stored in jars are some of the commoner black variety found in the desert; see grave 120, S.D. 81, and *Diospolis*, p. 33, B 217; p. 47, grave 21; others are the true scarabaeus, *Diospolis*, p. 32, B 17; p. 33, B 217; pp. 33-4, B 234. These many examples prove that the scarabaeus was venerated long before the earliest carved scarabaei of Neb-ka in the iird dynasty, and there is therefore no ground for questioning the age of those examples. Grave 27, S.D. 78, 4:3. (Cairo Museum.)

5. Carnelian beads threaded in groups of five, sewn on to linen cloth: this is the first time such beadwork has been found. Grave 36, S.D. 78; full size.

6. Figures of the fore-part or hind-part of a zebra drawn with ink on cylinder jars. The equine leg and tuft at the end of the tail identify the animal; and the stripes on the fore-quarter are therefore to be regarded as colour, and not as the ribs. Being headless, and cut in two, it seems as if the zebra had been hunted for food, as the horse was by the cave-

man of Europe. From the fore-part only being striped, and not the haunch, it is probably the quagga that is here represented, which was very common in recent times in South Africa, and may well have extended to Egypt. Grave 20, S.D. 78, 9:8. (Manchester, New York, Univ. Coll.)

36. Pl. iv, 1, 2, 7. Flaying knives of copper; this form is always thin and weak, rounded at the end, with a feeble handle, and sometimes a concave blade. It seems clearly adapted for removing skins which have to be carefully preserved. (Univ. Coll.)

3, 4, 5, 8. Copper chisels of the usual forms. (3 Cambridge, 4 Reading.)

6. Copper spear, already noted under i, 12. (Univ. Coll.)

9. Copper pick; a rather similar form is known from early prehistoric time for pinning hide together.

10. This may be a pick also, or possibly a pin.

11. The tip of a copper knife.

12. The end of a thin adze of copper. (Bristol.)

13. Stout axe of copper, the top straight and square, as always found before the ist dynasty. (Dublin.)

14. Copper axe approaching the type of axe of Kha-sekhemui (*Royal Tombs* II, xlv, 76). (Reading.)

Pl. v, 15. Copper adze found with no. 2 on the last plate. (Bristol.)

16-24. Set of model tools of copper, long knife, adze, chisels, and long axe.

25. Copper adze found with the chisel, fig. 4, and axe, fig. 122. (Reading.)

26, 28. Copper adzes, and, 27, narrow axe, found together. The slight stiffening ridge on the great adze is shown in the photograph, vi, 7. A slight rounding is seen on the large adze tip, and more on the lesser. (Manchester.)

29. Copper adze from grave of Tahuti-mer, beginning of ist dynasty, showing that the older square top had become quite rounded by then. (Univ. Coll.)

30. Copper armlet, the only one upon the arm; grave 250.

Pl. vi. Most of these have been already referred to in the previous account; 1 is iv, 2; 2 is v, 15; 3 is iv, 14; 4 is iv, 4; 5 is v, 25; 6 is iv, 13; 7, 8, 9 are v, 26, 27, 28; 10 is iv, 3.

11, 12, 13, are an axe with handle found in grave 509, of the xi-xiith dynasty. The handle, 11, is elaborately covered with interlacing string, actual size; 12 is the cap from the end of the handle; and 13 is the blade, 3:5. (Cairo Mus.)

14 is a horn or tortoiseshell armlet with copper strip binding; grave 269, actual size, S.D. 81.

15 is a copper adze from the grave of Tahuti-mer, 412, S.D. 78, 3:5. (Univ. Coll.)

Pl. vii. The flints were not numerous; they accord with the styles found in the south at Abydos.

1. See grave 22, undated.

2. Compare *Abydos* I, xvii, 34, S.D. 78 or 79.

4. Compare *Ab.* 116-122, S.D. 79.

5, Compare *Ab.* 42, which is from tomb M 13 of S.D. 79. (Cambridge Ethn.)

6. Compare *Ab.* xiv, knife handle and tip, of Y Merneit, S.D. 81. (Oxford P.R.)

14, 15. Copper bowls, mentioned in description of the graves. (Ashmolean, 15.)

37. Pl. viii. Mr. Engelbach has drawn and noted the bed construction, and gives the following account:

"In the cemetery of Tarkhan many of the early dynastic people were buried on their beds instead of in coffins, a few instances showing both together, the bed being laid over the coffin.

The beds vary very much in construction and workmanship, but may be classed under five general types, with every kind of gradation between them.

The webbing of the bed may vary from coarse rush matting tied round the poles to leather straps passing through well-cut strap-holes in the bedstead.

Samples of coarse rush webbing and ornamental palm-fibre matting are shown in pl. viii.

In the first type of bed-frame (see pl. viii, 4) each side consists of a rough knee-piece of wood with part of a branch at right angles to the stem, forming a side and a leg. A mortise is cut at the bend to receive the tenon of the end of the branch of another side, which is also provided with a leg; thus four similar pieces fit together, each having a mortise at the bend to receive the tenon of the next. In this type the webbing is woven round the frame.

The second type is somewhat similar; the end poles turn down into two legs, all formed from a single piece, the side-poles being straight and cut into tenons at each end. In this instance, although the workmanship is very rough, the webbing of the bed was attached to the frame by strap-holes. In two instances these beds had been put into the grave upside down, possibly as the legs had been broken prior to the burial, showing probably that an old bedstead was used. In both this and the preceding type the legs are slightly tapered and quite devoid of ornament.

The third and most common type consists of two

side-poles with the end-poles fitting into them by means of tenons, the bedstead being supported by four legs carved like the fore and hind-legs of an animal. These legs frequently have the muscles outlined by a broad line in relief. The poles may be either square, with the edges bevelled, or of circular section. These forms are shown in pl. viii, 3; and pl. ix, 8-10 gives a drawing to scale 1 : 10, of viii, 6, the largest and most perfect bedstead found in the cemetery, and shows the details of jointing, etc. The length of this bed is 69 inches, but smaller forms are found which may rather be couches than beds.

The fourth type has the end-poles cut in a joint halved in with the side-poles (pl. viii, 2); in other respects it is similar to the preceding type.

In the fifth form of bedstead, the danger of the end and side-poles coming apart from each other is obviated by making the tenons of the legs notched into the tenons of the end-poles (pl. viii, 1)."

Plate viii, 1. The late and coarse type of bed-frame, with the tenon of the leg pierced to let the tenon of the cross-bar pass through. Grave 90, S.D. 81.

2. The earlier type with animal legs, the leg pierced to lash it up to the pole; cross-bar halved on, and evidently retained by lashing.

3. The best type of frame, with animal legs, and the cross-bar fixed with tenon. Here the poles are too thin, and so pressure on the head-bar has split them. Grave 54, S.D. 79. The finest example of this type is the earliest of S.D. 77, see 6 and next plate 8-10.

4. Latest and most debased type, formed of four L-shaped pieces of wood, the top of the L being a tenon to fit into the bend of the next piece, the short side of the L being the leg. Grave 512, S.D. 81.

5. Walking-sticks; 62½ inches long, grave 426; 58½ inches, grave 480; 53½ inches, grave 299.

6. The finest bed-frame, 69 × 32 inches, the separate parts of which are drawn on ix, 8-10. The slots in the inner sides of the poles reach the axis where they meet similar slots from below. Thus the webbing of the bed-frame was put in without covering over the visible wood of the frame. Grave 144, S.D. 77. (Manchester Museum.)

7. Upon the previous bed-frame and webbing was placed a palm-fibre mat, woven in pattern, and stiffened down the long sides by being worked round two palm-sticks. (Cairo.)

8. Another pattern of webbing was of the twisted rush, closely like the modern rush-bottomed stools. The rush was passed round the pole, and then woven into cross-webbing of 4 strands wide.

Plate ix, 1-5. In many parts of the cemetery boards were found which had been re-used in coffins and for roofing the graves. These boards had originally been parts of some entirely different construction. The drawings here show the views and sections through the holes. In pl. x, 3, 4, are the views of two whole boards, which are the full height of the rooms, with the lashing-holes on each side. The larger board shows plainly the weathering outside of the part protected by the overlap. (Univ. Coll.)

These various types of holes are evidently for lashings, and in one of them there still remained a bit of twisted palm-fibre rope.

6, 7. In these plans are shown the various ways in which the different lashing-holes could be utilised to bind together boards overlapping one on the other. The dotted line in each marks the place of the binding cord.

It is obvious that such overlapping boards are exactly the prototype of the stone carving of panelled or recessed doorways, so well known in the Old Kingdom; the design of these was clumsily copied also in brickwork. That this recessed work was copied from overlapping woodwork, I had concluded before, from examining the details of construction shown on the Khufu-ankh sarcophagus in Cairo. See the form of the coffin, xxviii, evidently copied from a timbered house.

Here, then, we have the actual timbers of the wooden houses which served as the prototype of the stone forms, just as in Greece the wooden architecture originated all the stone forms. Why should such wooden houses have been invented? The present customs give the explanation. As soon as the green crops come up, the villagers move out into the fields, and build huts and enclosures of maize stalks to dwell in, so as to be close to their cattle at pasture and to enjoy the cooler air which comes over the vegetation. Here they live till the crops are done and the Nile rises. Then they go back to their houses on the village mounds or the desert. In the same way the early Egyptians probably moved to and fro each year. A wooden house would be used by the more prosperous people, and, as it needed to be moved twice a year, the lashing together of the boards was the best method of construction. As, owing to the extreme dryness, varied by winter rains and fogs, all wood expands and contracts considerably, the system of overlapping enabled enough motion to take place without opening any cracks or leaving gaps which let the wind blow directly in.

This system of overlapping planks was the best for the circumstances. From it we can see the obvious source of the idea of the wooden Tabernacle of the Israelites, built of vertical planks. This realisation of the actual woodwork which afterwards gave rise to the forms of the stone architecture, is perhaps the principal new result of the season's work. There has hitherto been no chance of recovering the wooden houses, as all the sites of that age are far beneath the Nile mud. Most of these planks are weathered on one side by exposure; and one of them is burnt on the other side by a fire in the house to which it belonged. (Manchester, Univ. Coll., New York.)

8-10 have been described under pl. viii.

11-13 are plans and sections of another form of jointing of bed-frames.

14-18. Arrow-points of hard wood, inserted in reed-stems. See x, 7, where the notch of an arrow is also shown. (Ashmolean.)

19. Unusual form of jointing the corners of a tray for burial beneath the body; the dimensions stated in inches.

Plate x. 1, 2. Basket and lid in firm condition, grave 125, S.D. 79. At the side of it another lid of a basket with the original string running through the top for a handle.

3, 4, described with previous plate.

5. Wooden chisels used in digging graves in the gravel. Grave 288 of unknown date.

6. Wooden shadūf hooks, one from grave 249, S.D. 81; the other from grave 558, of the iind or iiird dynasty (?).

7. Wooden arrow-heads, see ix, 14-18. Grave 1051, S.D. 77.

8. Linen ball bound with cord, for children to play with. Grave 518, S.D. 80.

9. Mop (?) of cord and thread.

10. Matting from a grave, put with 11, a modern Egyptian *hasyrah* mat, to show the exact similarity of the work, entirely unchanged in style during 7,000 years.

Plate xi. 20. Wooden model dagger, see photograph i, 1.

21. Wooden bowl, carved out of one piece, with a ledge handle left at the side, the suspension hole in which is broken out. (Univ. Coll.)

22, described under iii, 2.

23. Wooden table with four feet, see under-side xii, 7; this was doubtless used for standing vases and food on upon the ground, so as to keep them from the grit and dust. (Manchester.)

24. With 23 was also found the sandal tray; see xii, 10. The outline of a foot on the cross-bar indicates that it was intended for the foot to be placed on it, and the tray would naturally be for carrying the sandals ready to be strapped on. The bar in this is in one piece with the bottom, beneath the foot, only being pierced through near each end, as shown in the side-view. (Ashmolean.)

25. Wooden sandal-tray, see xii, 11, differing from the preceding by having the bar entirely cut through beneath. (Manchester.)

26. Wooden dipper, probably used for filling water-jars; see xii, 9. (New York.)

27. Wooden tray with sloping sides; see xii, 8. (Manchester.)

Plate xii. These objects are noticed with the drawings, which give accurate scale and grave number. 1 with vii, 6; 2 with xiii, 13; 3-5 with xiv, 31-33; 6 with xiii, 1-6; 7 with xi, 23; 8 with xi, 27; 9 with xi, 26; 10 with xi, 24; 11 with xi, 25.

38. Plate xiii, 1-6. Ivory spoon, carved with five rows of animals around it, and a couchant calf upon the handle; 1-3 show the sides and end continuously; 4 is the top view of the inside and handle; 5 is the water pattern on the bottom, and the development of the rows of animals round the handle; 6 is the end of the bowl joined by the handle and almost touched by the neck of the calf; see xii, 6. In style it is closely like the ivory carvings of the same age from Hierakonpolis (*Hier.* xiii, 2). The animals seem to be intended for oryxes and dogs. (Cairo Museum.)

7-15. Various ivory spoons, two of S.D. 77, five of S.D. 79, and one of S.D. 81. Thus the main period of burying such articles of luxury was the beginning of the ist dynasty; 12 has another piece of handle, actually extending to 5 inches from the bowl; 15 has a handle carved to imitate a snake; it was found broken, and the head could not be discovered. A carnelian bead was with it. (Ashmolean.)

Plate xiv, 16, 17. Animal legs for small stands, copied from the larger legs of wood, such as 18, used for seats and bed-frames. Similar carved legs were found in the royal tombs (*R.T.* I, xxxiv).

19. Alabaster case in the form of a scarab, described with iii, 4.

20-22. Gaming-pieces of ivory. Similar pieces were found in the tomb of Zer (S.D. 79) at the royal tombs, see *R.T.* I, xxxiv, 89, 90; xxxv, 5; and xxxii, 34.

24. Domed draughtsman.

25-26. Portions of a set similar to the next two.

27. Glazed beads found with 28-30.

28-30, 31-33. Sets of gaming-pieces. Similar sets of uniform rods of ivory have been found in the tomb of Zer (*R.T.* I, xxxiv, 56-61) and in prehistoric graves (*Naqada*, pp. 14, 26, 34, 35, pl. vii, lxi). The sizes vary so much (from 1.95 to 7 inches long) and so irregularly, that there does not seem to have been any standard size; they were usually equal in one set as in 33, but might be different as in 29. (Cambridge.)

34, 35. Gaming-pieces of ivory; see 20-22 similar.

36, 37. Hair-pins of ivory.

38, 39. Draughtsmen of ivory.

40-45. Various gaming-rods of ivory.

The majority of these gaming-pieces belong to the earlier period, before the changes of deterioration which set in clearly by S.D. 80.

The principal groups of beads that were found are shown at the bottom of this plate, and as the materials are named, further description is not needed.

CHAPTER VI

THE BURIALS

39. THE largest tomb found was a great mastaba, of the middle of the ist dynasty, S.D. 80, which Mr. Wainwright has fully described in a previous chapter, and illustrated in pls. xv-xx.

Plate xxi. The historically dated burials are figured here. They had all been plundered anciently. Grave 412 is shown in two views, one taken from each end; the connection of them is best seen by looking at the jars opposite the letters A, B, C on the right side of each. This grave contained the name Tahuti-mer, xxxi, 71, and by its form and position it is clearly of the same age as the adjacent grave with the name of Narmer.

414. This grave contained the large jar with falcon name of Nar-mer, xxxi, 68 (*Univ. Coll.*), and impressions of four seals (ii, 1-4) on the clay capping of jars, which had been broken up by the plunderers.

261. This grave contained a cylinder jar, with the name of King Ka, thus dating it to some time before Mena.

All of these graves are in plan, section A, pl. lxx. They have been described in the accounts of separate graves under S.D. 78.

Plate xxii. 170 is remarkable for having two

bodies in one coffin, placed head to feet. Described under S.D. 80.

1034. Two adult burials, one in front of the other, and a child buried in a pottery coffin. Alabaster jars to the right of the coffin. Described under S.D. 81.

1035. Body in mud coffin; note the head reversed. Such coffins were rare at Tarkhan, where wood was commonly used, but they were common at Turah. See under S.D. 81.

1007. A dismembered burial with all the bones out of connection, but roughly placed in the order of a contracted burial. As no pottery was found with this, it cannot be dated.

479 is a view of a pit in which wooden hoes and chisels were found left with a basket and a bowl, but without any burial. It seems to have been an unfinished grave left by the workmen, like one at Deshasheh (*Desh.* 33).

Plate xxiii. First is a burial capped with a thick layer of mud, belonging to a type of which many examples were found and cleared by Mr. Mackay, to the east of group B, pl. lxix. These are later than the ist dynasty, and will be described in the second volume.

257. The peculiar position of the roofing-poles placed diagonally over this grave is seen here.

42. Grave with large roofing-beam, 6 inches thick. Contents described under S.D. 78.

3. Roofing intact, with short branches put below three long branches. This arrangement was probably because the reed-covering went across the grave, and the long poles were to prevent the reeds slipping between the cross-poles. Described under S.D. 79.

Pl. xxiv, 175. Top view of coffin cut out of a single log, and position of bones in it found dis-severed, after removing cloth covering. The lid has a handle at one end; probably this was originally a clothes-box, as it is much too small for a coffin. See under S.D. 79. (*Brussels.*)

175. End view of the above coffin to show the absence of joints.

203. Coffin of which the sides and base are cut from a single block, while each end is made of two boards inserted by halving in to the sides. See under S.D. 79.

At the bottom is a photograph, nearly full size, of a roughly sawn surface of a coffin, which shows the varying direction of the sawing.

Pl. xxv, 216. A burial in a recess, of the iird-ivth

dynasty, showing the mode of bricking up the opening, and the position of the coffin when the bricks are removed.

207. Reed coffin, unopened, with rope tied round it.

The same opened, showing a contracted burial, with head-rest formed of a single piece of wood. iiiird-ivth dynasty.

Pl. xxvi, 529. Basket-work coffin, date not fixed by pottery; probably of late ist or iind dynasty.

1004. Basket coffin with lid on, and with lid removed showing body tied up in a lump of cloth. The head-rest was found in fragments in the open pit outside of the bricked-up recess. See undated graves. Now in Cairo Museum.

Pl. xxvii, 902. Contracted burial in wooden coffin, S.D. 80. This burial was remarkable for the perfect condition of the linen upon it, which was not in any way discoloured. Yet there was no trace of flesh or skin between the linen and the bones. To suppose that the whole of the flesh would disappear by oxidation, while the linen over it remained entirely clean of stain, and firm without any oxidation, seems quite impossible. Unless some parallel case can prove such selective change possible, we must accept the fact that the bones were entirely unfleshed, and then wrapped up as seen in the photograph.

217. An instance of a coffin in a recess, with ropes still around it.

208. Contracted burial in a long coffin, with natural branch head-rest. Compare contracted burial with similar head-rest in 207, pl. xxv.

234. Full-length burial in long coffin, the head on a composite head-rest, built up with stick supports. Classed by Mr. Mackay among the vith-dynasty burials.

286. Long coffin of thick wood, with original ropes still around it. Beyond that two other long coffins of thick wood, probably of the vith dynasty or later.

Pl. xxviii. Coffin of the early iiiird dynasty probably, grave 532. The front of it shows the copying of the wooden house type. The three doorways with rounded beams over them are imitated, the two wider spaces between being copied from wide openings barred across to exclude men and animals from the house when the shutters behind the bars were opened. The slightly curved roof is still known in Nubian houses.

Below are seen the inside of the curved lid, showing its construction, also the coffin as it stood in its rock pit; and the same, opened, showing the body with three cross-bars of the lid fallen upon it.

A similar coffin was found by Mr. Quibell by the tomb of Hesy at Saqqareh, which belongs to about the beginning of the iiiird dynasty. (Cairo.)

STAIRWAY TOMBS. There remain to be noticed three tombs which are not photographed. One, 1004, is that which contained, in a recess, the best basket coffin, now at Cairo. The stairway is 16 inches wide, with four steps down to a pit 30 long by 50 wide; in the end of it was the recess 25 wide spreading to 40, and 56 deep inwards. This was recorded by Mr. Wainwright. Two others are recorded by Mr. Mackay.

Grave 240 had a shaft N. 85, E. $43\frac{1}{2}$, 125 deep, with six steep steps on E. On the W. a recess N. 39, E. 48, 32 high; in it, a contracted burial in a box coffin, entrance closed by stone slab. The three alabaster vases in this grave agree well to others of S.D. 81, and there seems no reason to doubt this dating, as other stairway graves have been found at Naga ed Deir of this age.

Grave 545 had a shaft N. 115, E. 38, 180 deep, descent by steps on E. On W. a recess N. 60, E. $41\frac{1}{2}$, 35 high; in it a contracted burial in a panelled box coffin, much decayed; entrance closed by small blocks of stone with mud mortar. A later shaft had been cut into the chamber and disturbed it. At the bottom of the shaft of 545, which was undisturbed, were pieces of a pottery jar, type 68 I, which belongs to S.D. 81, 82.

CHAPTER VII

THE SLATE PALETTES, MARKS, CORPUS, AND REGISTERS

40. Pl. xxix. The slate palettes are mostly of forms that are already well known in Upper Egypt. Several of them had still upon them the patch of malachite which was ground; and one of the quartz grinding pebbles, 12, has much of the surface in the middle covered with malachite, lightly shaded in the drawing. The new type is that of the slate copied from a fish form, and slightly hollowed as a dish, 29, 30. The smaller is dated to 81, but the larger one had nothing else with it by which to date it. The figure of the couchant gazelle, 27 (see i, 5), is better worked than any slates found at Naqadeh or Diospolis.

Pl. xxx, 1-5. The sealings found in mastaba 1060 differ from any found in the Royal Tombs; but they most resemble the style of those from the tomb of Zer (*R. T.* II, xvi) and Zet (*R. T.* I, xix), and may well date in the reign of Zet, s.d. 80, between these two royal burials. Compare 1 with *R. T.*, sealing 43; 2 with *R. T.* 16.

The marks are, many of them, already known at the Royal Tombs, which may naturally result from jars being sent from a single factory or from a single vineyard. The connections of the more distinctive and peculiar marks that may be noticed are:

Tomb 1060 s.d. 80.	Mark	s.d.	Royal Tombs I		Royal Tombs II	
			Mark	s.d.	Mark	s.d.
14	89	79	594-601	80, 81	179, 180	79-80
20	132	81	545	81		J 80
25	127	81				
27-9	136	81	669-695	80-82		
30	118	81	1122-	80, 81	74, 365	79
32	85	79	...		175	81
36	123	81	499-504	80-82	142-150	79-81
37	155	81	552-6	80, 81	166	81
38	88	79				
40	84	79			162	81
43			914-33	80, 81		
64	140	81	...		492	80
	83	81	513-8	81, 82		J 80
	104	?	...		234, 337	81
	117	80	...		457	80
	118	81	158, 1067	81, 82		
	121	81	...		322	81
	138-9	81	...		39, 40	81
	172	81	859	80		
	189	81	...		96-8	81

In the last column are two signs quoted from Junker, marked J, with date 80. As the range of marks at the Royal Tombs, closely dated, ranges over two, and sometimes three, units of date, it is not surprising to see differences of one unit between tomb 1060 and the parallel examples. But 1060 cannot be shifted either earlier or later on the strength of the marks, as they balance some each way. The other marks, 83 to 189, agree exactly with Royal Tomb datings in six, and only differ in one by a single unit. On the further question of the purpose of such marks see *The Formation of the Alphabet*, 1912.

65-71. These regular hieroglyphic writings in ink, and cut on pottery, 68, have already been

noticed in describing the graves in which they were found.

66, 67, are of king Ka.

68 is of Nar-mer.

69, probably of Nar-mer.

70 is illegible, but by the outer signs, like the last, it is perhaps of Nar-mer.

71 is of a private person, Tahuti-mer.

41. THE CORPUS. Pls. xxxii to xliv. Stone vases. Here all the forms of stone vase found at Tarkhan and at Turah are drawn to a scale of 1:2, reduced to 1:3. The system of registering is to have a number for each distinct type, and add a letter for the minor variations. The numbers are not consecutive, as room is left for the insertion of other types of the Old Kingdom, when this *corpus* is completed down to the vith dynasty. The reference-number and letter are at the top right-hand. The sequence-date number is at the bottom right hand, and the grave number at the bottom left hand. J is put to those types only found and published by Dr. Junker.

Pl. xlv. List of types of stone vases, with the number of examples, recorded under each sequence-date. As there are only six dates concerned here, 77-82, each date has a separate column of numbers assigned to it, divided by a dotted line between 79 and 80. Thus it is easy to see whether the number is at the left, middle, or right of each division. The actual number of examples is shown by Roman numerals. As the letters denote only minor differences, the general range of a type is seen by viewing all the examples of the same number, such as 24 or 62. Some varieties began earlier, as 24 *c, g*; then followed 24 *e, j, r*; and the main frequency is in s.d. 81, with 24 *l, p, r, t, v*. In 62 none are known before 79, and the main period is 81. Other types were earlier, such as 51, mainly in 78, with some appearing in 80. Where no dating is known a circle is put on the dividing line. J is put for examples of date in Junker's Turah cemetery.

Pls. xlvi to lviii. Pottery vases. The arrangement is like that of the stone vase drawings; only, as the number of examples is so much greater, the grave numbers are omitted; they can be found quickly by looking over the register tables, lx-lxvii. It can be seen from this table, which forms a diagram, how common certain types are, such as 12, 46-50, 59, 60, 63, 65, where dozens are recorded to each; while others are known only by single examples. This denoting of the number of examples is very needful

for judging of the range of date for a grave. It would be absurd, for instance, in 485 to say that a grave with it might be 81 when only a single instance is known so late, and nearly all are on 78. In this list the number of instances in the dateable groups of Dr. Junker are shown by the number *following* J; as in 50 *t* there are fifteen in Junker of 80 S.D., 1 at Tarkhan, and 1 of Junker of 81 S.D.

The use of these tables is both for testing the degree of certainty of the dates of the graves in the register here, and also for ascertaining the dates for any further tomb-groups that may be found.

42. THE REGISTER. Pls. lx-lxvii. The detail of the formation of the register by the dating of the graves has been described in the chapter on the dating of the graves. The meaning of the several columns is stated at the foot of the first page, lx. It must be remembered that the dating is not equally definite for each grave. Many cannot be put to any other date; others have a possible range of two or three units, and such are entered here to the middle of their range. Before any important conclusions are drawn from the date of any grave, the pottery and stone should be looked up in the tables of types, xlv, lix, remembering always that one stroke in the table is due to the grave which is being studied, and only the remaining numbers show other evidence for the date of the type referred to. Thus it will be seen what range the date of the grave in question may have. It may be thought that too many shades of form have been expressed by the letters, and no doubt many of them might safely be lumped together. But it is hopeless to find variations that are significant unless we denote variations by a more minute scale than that of the changes which may be of consequence. To take a parallel, we can never detect variations of inches in a building if we only measure to the nearest foot.

Regarding other excavators' results: Dr. Junker's contents of graves being already expressed by a uniform *corpus*, all of his groups of any significant size are here included; Dr. Reisner's graves being registered by separate photographs and drawings, his group-photographs (so far as they can be safely identified) are here given, but the drawings are rather too small to show the differences of type safely. Drawings that are not tabulated to any uniform *corpus* can hardly be used in general reference; the necessary work of tabulated registering must always be done by the finder.

Pl. lviii. To save comparison of drawings by

future students, a table is here given of conversion of the prehistoric *corpus* numbers into the present *corpus*, so far as those types survived. Also a table of conversion of all Junker's *corpus* numbers into the uniform *corpus* here given for both pottery and stone.

43. PLANS. Pls. lxxix to lxxvi. Pl. lxxix shows, at the top left, the outline of the district from Kafr Ammar to Gerzeh, where the prehistoric cemetery was excavated last year by Mr. Wainwright. This year's work is delimited by a square marked "Cemetery" at the north end.

The plan of the cemetery has the contours sketched in, to show the general position. It will be seen that nearly all the knolls and high ground contained cemeteries, which were excavated and planned. The lower ground and valleys also contain graves, but these, being covered with thick sand, were left alone, to be excavated in the following year. It is intended to issue a more detailed and precise plan when the work is finished there, but the present outline will suffice to show the relation of the different cemetery plans following this.

Pls. lxx to lxxvi. The separate cemeteries are here given in detail, with each hole that was dug marked down. The solid black marks are the early graves that we deal with in this volume. The later shaft graves and tombs are marked with an open square with diagonal lines across it. All graves of which the numbers are stated, are referred to by a list in the margin, with the entries opposite to the grave, and with the sequence-date. This list enables any numbered grave to be quickly traced.

The numbering of the graves was done by writing on pieces of white limestone, and putting the mark by the grave, with another stone on it to protect it. Unhappily the limestone proved very liable to crumble away when thus protected; exposed marks lasted better, although we had violent storms of wind and rain. When we came to do the survey the larger part of the marks proved illegible. Hence not nearly so many graves are numbered here as were registered. Roughly speaking, from my own share of the work nearly two-thirds of the pits were registrable, others containing nothing or only a few fragments of undateable pottery; of these two-thirds, about half, lost their numbers, so that one-third of my pits are numbered. Though there was some crossing of workers, yet the general allotment of the ground resulted in the following distribution among the four responsible for registration.

	F.P.	E.M.	G.W.	R.E.	Total.
Total of pits . . .	165	457	388	191	1201
Card registers . . .	94	153	141	268	656
Graves numbered	51	65	22	29	167

The total of cards filled up with registers was 656, of which 304 are dateable to the early period dealt with in this volume. Mr. Wainwright's register numbers were all over 1000. Mr. Engelbach registered many on Mr. Mackay's ground. The general survey was done by myself, and the laying out of the lines for offset work. Plans A to H, K to O, were filled in by myself, J was filled in by Mr. Engelbach, P to S by Mr. Wainwright. Mr. Mackay supplemented later graves, mainly in E.F. Beside doing the 165 named above, I also cleared and registered many on the grounds of other workers whenever there was any pressure of work.

In the plans, xi, xxiii, and other marks, are occasionally put to graves, showing the dynasties of late graves which are not numbered.

The general periods of the various cemeteries can be readily seen by looking down the marginal dates. A is of 78 to 80, B 77 to 79, C, D are almost entirely late, E is mostly of vi to xi dynasties, but with a few early graves of 77 and on. F is mainly early and xi dynasty. G was all early, 78-79, and finely lined graves. H was from 78 to 81, and J mainly of the middle period 79 to 81. L had a few early graves, but was mainly late. N was the earliest, being all of 77. The other cemeteries have not enough dated graves to specify, but P to S contained a large quantity of late stone vases of S.D. 81 registered with numbers over 1000. The cemetery of Turah was far more regularly occupied; all of one end is of S.D. 78, all the other end 80 and a few 81, and the middle S.D. 78, 79, and 80 mixed.

PLACES TO WHICH STONE VASES AND GROUPS HAVE BEEN SENT

Aberdeen : 187, 240, 512.
 Bolton : 143, 1028.
 Brighton : 297, 1003.
 Bristol : 89, 112, 170, 297, 1003, 1011.
 Brussels : 53, 552.
 Cambridge Ethnol. : 118, 133, 212, 1059, 1062.
 „ Fitzwilliam : 80, 204, 351, 1060.
 Cape of Good Hope : 54, 104, 108, 149, 177, 199, 294,
 431, 1008, 1012.
 Carlsberg : 146, 189, 219, 230.

Dublin : 149, 213, 231, 233, 1020.
 Glasgow : 24, 82, 263, 269, 312, 1034, 1042.
 Leicester : 167, 230, 238, 283.
 Manchester : 7, 21, 89, 101, 136, 1015.
 Newark : 86, 117, 127, 1016.
 Oxford, Ashmolean : 126, 160, 178, 231, 312, 474, 1031.
 „ Pitt Rivers : 149, 158.
 Reading : 89, 1020, 1025, 1029.
 Rochdale : 249, 298, 1017.
 University College, London : 10, 13, 19, 20, 36, 61,
 81, 85, 100, 107, 153, 165, 191, 231, 250, 261, 315,
 414, 1023.

LIST OF GRAVES, DESCRIBED IN THE ORDER OF THE SEQUENCE-DATES, CHAPTER III

Grave.	Date.	Grave.	Date.
3	79	203	79
8	78	204	80
9	78	213	81
16	78	230	80
20	78	231	81
27	78	260	78
37	78	261	78
39	78	278	79
42	78	279	79
43	78	315	77
54	79	412	78
60	80	414	78
61	81	415	80
80	80	432	80
86	77	466	77
88	81	474	79
89	81	527	77
96	N.D.	538	80
101	81	804	77
104	77	901	78
107	81	1004	N.D.
120	81	1006	77
122	81	1007	N.D.
136	81	1013	80
137	80	1015	77
141	77	1016	81
144	77	1018	81
149	80	1023	78
158	81	1034	81
169	81	1037	77
170	80	1051	77
175	79	1060	80
195	80	1062	77
197	78	1063	77

REFERENCES FROM THE GRAVE NUMBERS TO THE PLATES

All stone vases and pottery references are given in the register lx-lxvii

Lithograph.	Grave.	Photo-graph.	Lithograph.	Grave.	Photo-graph.	Lithograph.	Grave.	Photo-graph.
	3	xxiii	vii 10	181		xxix 11	351 a	
iv 13	7	vi 6	xxix 1	185		v 29, vii 15, xxxi 71	412	vi 15, xxi
xiv 31-3	10	xii 3-5	xiv 40-41	186		ii 1-4, xxxi 68	414	xxi
vii 14, xxix	16		ii 5	187		xiv 53, xxix 21,	415	
iv 2, v 15, vii 12	17	vi 1, 2	xiv 52	190		xxxi 69		
xi 20	20	i 1, iii 6	xiii 9, xiv 42-4, 46-7,	195		xiv 62	416	
xiii 8, xiv 38-9	21		xxix 14, 15			xxix 23	419	
iv 1, 7, vii 1, xiv 55	22			203	xxiv	ii 6	422	
xiv 19	27	iii 4		207	xxv	xi 21	453	
	36	iii 5		208	xxvii	iv 6, xiii 10	474	i 12
iv 12	37		xxix 25	212		xiii 15	501	
xxix 3	41		ii 11, xi 22	213	i 7, iii 2		509	vi 11-13
	42	xxiii		216	xxv		512	viii 4
xxix 12-13	52			217	xxvii		529	xxvi
vii 8, 9	53	i 2		231	iii 1		532	xxviii
xxix 17	54	viii 3		234	xxvii		902	xxvii
iv 11	80		ix 19	250			1004	xxvi
xxix 9	81		vii 7	256			1007	xxii
xiii 13, xiv 50, xxix 10	86	xii 2		257	xxiii		1015	vi 7-9
xxix 27	87	i 5	xiv 48, xxix 7	260		v 26-8	1023	xii 6
	90	viii 1	xiv 51, xxxi 67	261	i 6, xxi	v 16-24, xiii 1-6	1026	
ii 14, 15, xiv 58	97		xxix 16	263		xxix 22	1034	xxii
xxix 8	104	i 11	ii 7, 8, 12, xiv 60-61	269	vi 14		1035	xxii
	112	i 8	xiv 27-30	271			1037	
ii 10, xiv 17, xxix 24, 29	117		ii 13, 16, xiv 57	278		vii 5	1040	
vii 3	118		ii 6	279		xiv 59	1041	
iv 4, 14, v 25	122	vi 3-5		286	xxvii	xiv 20-23	1047	
ii 9	130		ii 6, xiv 56	293		xxix 5	1051	x 7
vii 13	131		xxx 70	300		ix 14-18	1054	
xi 23, 24	136	xii 7	xxix 30	310	i 10	vii 4	1058	
xi 25, 27	144	xii 8, 9	xiv 49	311		xiii 7	1059	vi 10
xxx 65	148		xxix 18, 20	312		iv 3	1060	xv, xvi, xvii
	149	iii 3	xxx 66	315	i 4	xviii, xix, xx		
ii 21, vii 6, xi 26	158	xii 1, 11	xiii 14	319		xxix 19, xxx		
xiii 11	165		xxix 6	320		xiii 12, xiv 24	1061	
iv 5	170	xxii	xxix 6	323		xxix 28	1063	i 9
	175	xxiv	vii 2	336				
xiv 54	178							

MEMPHIS

CHAPTER VIII

THE EXCAVATIONS

44. WHEN first surveying the position of the wall which surrounded the great temenos of Ptah, I had noted some blocks of granite on the northern side, and expected that these would show the place of the great north gateway, which is described by Herodotus as having been built by Moeris—Amenemhat III, of the xiith dynasty. With the view of searching for the gate, this part was taken in hand as the main Memphite work of this year, Mr. Mackay being in charge of this site.

The position of the north wall I had presumed to be shown by the pathway which leads eastward from the north end of the village of Mitraheny. Such proved to be the case, doubtless owing to the harder brickwork giving a better footing amid the swampy low ground. The present *saqieh* water-wheel for irrigation is just inside the wall, and just west of the gap of the gateway.

The remains found seem to show two periods, that of the xiith and xixth dynasties. Of the earlier work there remain two great blocks of quartzite, mainly lying north of the great wall. One is part of a gateway jamb 7 feet high, running 9 feet 7 inches along the thickness of the gateway, and 3 feet 4 inches thick. Fifty feet south of this lies the fallen lintel, deep down; it is 12 feet 11 inches long, 4 feet 2 inches high, and 30 inches thick. The inscription on it is shown at the top of pl. lxxvii, "the king Ne · maat · ra giving life eternally". This grand block of Amenemhat III thus shows that Herodotus was correctly informed as to the builder of this gateway. The plan of these and other remains is not given, as it is hoped to extend it further this year.

The present form of the great brick wall is probably Ramesside. The thickness of this gateway is $36\frac{1}{2}$ feet; and the gap in the brickwork formerly filled by the stonework of the gate, is 115 feet wide. Of the great stone gateway nothing remains, such large blocks of squared stone were

the most attractive to later builders. South of the inner face of the wall are four column bases; three in a row, and doubtless another missing; the fourth base being one of a second row. These seem to have been part of a colonnade entrance way, with four files of columns, and five lines of path. They cannot be part of a peristyle hall as they are too close to the great wall. Nor can they be merely bases re-used for foundation—as is often the case—because on one of them is still standing part of a column in place. The bases are 15 feet 6 inches wide, with a space of 4 feet 7 inches between them; thus the columns were 20 feet 1 inch centre to centre, and being 5 feet 11 inches diameter, the intercolumniation was 14 feet 2 inches, or $2\cdot40$ diameters. The axis of this colonnade gateway was rather east of the earlier gateway; for it lies $16\frac{1}{2}$ feet from the early jamb, and we cannot suppose a gateway of 33 feet wide.

Outside of the great wall a clearing was made 65 feet northward and about 200 feet along each face, without meeting with any statuary or monuments.

45. Scattered within the temenos were found two groups of foundation blocks and five large monuments, in the cleared area of about 130 by 400 feet.

(1) The red-granite dyad of Ramessu II and Ptah; see pl. lxxvii, and the side-view of the upper part of the figures on pl. lxxviii. The work is as good as any red-granite work of that age, and the faces are absolutely perfect, as we have noticed to be the case on other statues of Memphis. The inscriptions are only the usual titles and devotions to Ptah, found on innumerable other monuments. The crowns were cut in a separate block, and the figures had been broken clean in two by falling over. The whole height is 5 cubits, 8 feet $7\frac{1}{2}$ inches, width 4 feet 8 inches, thickness 25 inches. This group is now at Ny Carlsberg Museum.

(2) Another dyad of the king and Osiris was found, but was too badly injured to be removed.

(3) The red-granite sphinx of Ramessu II is 11 feet 5 inches long, and 7 feet $1\frac{1}{2}$ inches high, see top of

pl. lxxviii. Unfortunately the head has remained exposed after the body was covered with rubbish, and it has thus been weathered away. This has been raised, and will be sent shortly to a museum.

(4) The quartzite sandstone seated figure of a scribe, (see base of pl. lxxviii), is unfortunately headless. Perhaps one of the various quartzite heads now in museums will be found to fit it. It is of a scribe Amenhotep, who lived under Amenhotep III. Except on the lap the inscriptions around it are in perfect condition; and are here given, from paper squeezes, on pls. lxxix, lxxx. They have been carefully revised by Dr. Alan Gardiner, who has kindly contributed a discussion of them in the next chapter. This figure is now in the Ashmolean Museum, Oxford.

(5) An alabaster head of a colossus, 45 inches from the top of wig to base of beard, is apparently of Ramessu II. It was too much injured to be removed.

(6) A limestone head, about half life size, shown on pl. lxxviii, is of very good work, but much bruised. Ny Carlsberg Museum.

At the base of pl. lxxviii is part of a trial-piece of a golden vulture, the hieroglyph *a*, found in some digging in the city.

CHAPTER IX

THE INSCRIPTION OF AMENHOTEP

By ALAN H. GARDINER, D. Litt.

46. THE statue of the Royal Scribe Amenhotep (pl. lxxviii) is chiefly remarkable for the wealth of inscriptions that cover it on all sides (pls. lxxix, lxxx). In itself, it does not differ in any essential particular from other statues of scribes of the Eighteenth Dynasty. The high dignitary portrayed is represented in the usual attitude, seated cross-legged, his papyrus extended on his lap ready for use. The head is missing, and with it have disappeared a few words from each of the vertical columns of hieroglyphs that occupied the right-hand side (ll. 19-20) and back (ll. 21-26) of the plinth. The inscriptions, which form a continuous text, are otherwise complete, except where the quartzite sandstone in which the statue is carved has weathered, or has been bruised, so as to render the signs illegible. The text begins on the unrolled papyrus in the lap (ll. 1-7), thence continues on to the top (ll. 8-10) and front (ll. 11-14) surfaces of the base, thence along the side of the base under the right arm (ll. 15-18) to the back (ll. 19-20,

21-26), from here on to the left thigh (ll. 23-24), and finally to the upper (l. 44) and vertical (ll. 45-49) surfaces of the left side of the base.

Translation

(1) (This statue was) given as a favour [from the King] (and placed) in the House of Nib-mu-rē¹ (named) "United-with-Ptah" which his Majesty newly made for (2) his father [Ptah South-of-his-Wall in his] cultivated land² west of Het-ke-Ptah³; on behalf of the hereditary prince and toparch, treasurer of the King of Lower Egypt, loved of the Lord of the Two Lands, (3) great [in his rank and exalted in his office], a magistrate at the head of the King's notables, the eyes of the King of Upper Egypt and the ears (4) [of] the King of Lower Egypt, . . . [well-acquainted] with the way to the Palace, the mouth that gives satisfaction in the Royal dwellingplace, excellent of (5) speech(?) . . . the veritable scribe of [the King] beloved of him, Amenhotep.

He says :

I speak to your worships, (6) ye who are yet to come into being, [men] of the future [who shall live] upon earth. I served the Good God, the [joyful(?)]⁴ prince, (7) the King of Upper and Lower Egypt Nib-mu-rē, when I was young and without kindred (?). When I was grown old and . . . (8) . . . I entered into the Palace when he was in private, so as to behold Horus in this his house; and the nobles walked behind(?). (9) He gave me marks of favour on account of my excellent demeanour, and promoted me [to be] Chief Steward, and my stick was on the heads of the people. I became wealthy (10) in serfs, cattle and possessions of all kinds without a limit, and [there was nought] to be desired, by (11) the favours of the Lord of the Two Lands Horus Kham-māet. I performed Right [for . . .] Re, for I knew that (12) he lives thereon; my abhorrence was [false]-speaking.

He promoted me (13) to direct the constructions in his House of Millions of Years, which he newly made in his cultivated land west of Het-ke-Ptah (14) in the district (?) of Enkh-toue⁵—it was his father Ptah who

¹ Amenophis III; note the unusual manner of writing the pre-nomen with a single sign, here and several times below.

² Lit. "ground liable to be inundated."

³ A common designation of Memphis.

⁴ I can suggest nothing but *sw yeb*—though there is no trace of the downward curve to the right of the upper sign.

⁵ Another name for the region of Memphis.

. . . and waited (?)¹ —(15) as a monument for his father Ptah in excellent eternal work in white stone of Ain. Its beauty was as the horizon of heaven; all its doors were of cedar of the Terraces, of the choicest of Gau, (16) wrought with gold from the desert, refined gold, and all kinds of precious stones. (Its) halls and (its) gateways were of . . . ; a great . . . of everlasting work as a rampart (17) of fortification. Its lake was dug, and planted with trees, and made radiant with every kind of precious wood of the choicest of the Divine Land. Its vessel-stands [were of] silver and gold . . . and all manner of hard stones.

(18) Now when these constructions had been completed in beauteous fashion, his Majesty instituted new divine offerings consisting of daily oblations to his father Ptah South-of-his-Wall and to the gods of [this] House; (19) they being supplied with food for ever. And he appointed *wēb*-priests and prophets of the children of the magnates of Inbu,² and appointed fields and cattle, field-labourers and herdsmen [from the] (20) spoils of his Majesty which he had brought back from every land. All the offices of this temple his Majesty filled right well, and it was his Majesty who performed it (thus) worthily and lovingly (?). (21) . . . And his Majesty caused this House to contribute provisions (?) to the House of Ptah in all its statutes even as the Houses of the Kings of Upper and Lower Egypt which are beside his father Amon in the Southern City; it being controlled by every steward of the King (22) . . . its bread for ever.

Now behold, I appointed property by written deed out of my fields, my serfs and my cattle on behalf of the statue of Nib-mu-rē whose name is . . . (23) which his Majesty [had made] for his father Ptah in this sanctuary. Specification of the same:—

Fields, 210½ acres.

In the Northern Province, fields 220 acres, of what had been given to me by the favours of the King.

Total, fields, [430½] acres.

[in addition to . . .] (24) . . . 10 . . . 1000 egg-laying geese, 1000 pigs, 1000 young (?) pigs. His Majesty praised me on account of it, inasmuch as I appeared excellent in his heart. I attained a venerable age in the favour of the King, and I delivered up (my) bodily frame(?)³ to the sarco-

phagus after a lengthy old age; I became united with my tomb [in the Necropolis . . .]. (25) My [respect] was with the courtiers, my love with all men, and my favour was established in the Palace.

His Majesty gave to me divine offerings of that which had gone up before his processional statue in his House "United with Ptah" [which he made in (26) his cultivated land west of] Het-ke-Ptah. When moreover the god has sated himself with his possessions and this statue (also) has received its meals then provisions shall be caused to go up before this humble servant by the hand of the lector who is in his house, and the *wēb*-priest of the hour shall make offering . . . (27) . . . [according to the] ritual in the course of every day. List thereof:—*bit*-cakes (amount used in cooking 30), 20 cakes; *bit*-cakes (amount used in cooking 40), 30 cakes; *bit*-cakes (amount used in cooking 100), 100 cakes; *persen*-cakes (amount used in cooking 30), 20 cakes; *persen*-cakes (amount used in cooking 40), 30 cakes; total, various kinds of offering-bread, 200. Beer (28), (amount used in brewing 30), 10 jars; lard (?) 2 jars (?); one fore-leg of every bull that is delivered in (29) this House; wine, 1 *hin*; milk, one pail; cakes (30) of white bread, 2; ordinary geese, 1; vegetables, 6 bundles; . . . 3.

(31) (Thus) say I:—Listen, ye *wēb*-priests, lectors and prophets of "United with Ptah," and every steward of the King (32) who shall exist hereafter in Inbu. His Majesty has given to you¹ (33) bread and beer, meat and cakes, and all manner of goodly things to nourish you in (34) his House "United with Amon" in the course of every day. Do not covet (35) my provisions which my own (?) god decreed for me so as to do me (36) honour² at my tomb. I have not made mention of more than my own belongings I have not demanded aught (37) over and above; forasmuch as I appointed property by written deed for this statue of the King which is in (38) this House in exchange for his giving to me divine offerings of the offerings that come in and go up (39) before his processional statue after the ritual-sacrifice has been made, so as to establish my provisions (40) for future generations yet to come. For I was a man (41) just upon earth, of whom his god knew that he would

¹ As it stands, the text can only be translated, "His Majesty has given to me and to you," though even here there is a grammatical difficulty. The argument is, however, evidently as follows: You have been already provided for by the King; therefore do not covet my portion.

² Lit. "to pour water for me" the expression must be understood in a wider sense.

¹ I have attempted to render this difficult sentence literally, but do not understand the sense.

² Yet another name for Memphis.

³ Lit. "wood."

increase his beauty, one who acted well to the servants (42) of his house. I drove no man from his rank. I cheated (43) none other of his possessions. I took not away the possessions of others by fraud. My abhorrence (44) was cheating.

This I say too further. Every steward of the King whom there shall be in Memphis, every scribe, every lector, and every *wēb*-priest of this House, the lay-priests of the entire temple, (45) and whomsoever there shall be in this House who shall hinder my provisions which Ptah South-of-his-Wall decreed, (even) my noble god who lives upon truth and who fashioned his own form, of that which the King Nib-mu-rē gives to me so as to make offering to me at my tomb by reason of the greatness of my favour with him; (such a one) shall this (46) noble god visit with his displeasure; his office shall be taken away before his face, and given to a man who is his enemy; his *kā* shall be absent from him,¹ his house shall fall to the ground.

But every steward of the King whom there shall be in Inbu, every scribe, every lector and every *wēb*-priest of this (47) House, the lay-priests of the entire temple, and whomsoever there shall be in this House who shall grant my provisions to the lector who is in my house in the course of every day; him shall this noble god praise; he shall pass his life in peace and without strife; he shall [attain] (48) a venerable age and hand on his office to his children after a prolonged old age; all his years shall be happy and without sorrow; his name shall be good among men, and no evil shall come upon him. For I was (49) a man just and equitable upon earth. I gave bread to the hungry, water to the thirsty. I did that which men are pleased (withal) and that which the gods praise.

47. The statue of Amenhotep was not found *in situ* and we lack direct archæological evidence as to the location of the sanctuary where, as the first line of the inscription relates, the favour of King Amenophis III caused it to be set up. This sanctuary is often referred to in the text as "the House of Nib-mu-rē 'United with Ptah'" and once is called "his (the King's) House of Millions of Years" (l. 13). The latter epithet implies that the temple belongs to those known as funerary temples, a Memphite counterpart of the great edifice which Amenophis III built at Thebes, and of which little now remains except

¹ This unusual phrase seems to mean: his needs and appetites shall not be satisfied.

the famous Colossi. It is probable that this Memphite temple, like the Theban one just named, stood on the very fringe of the cultivation; and with this agrees the statement that it was erected on "the cultivated ground *west* of Het-ke-Ptah (ll. 2 and 13). For the proper understanding of our inscription it is necessary to make sure that the nature of such funerary temples is rightly apprehended. Historically viewed, they are the descendants of the old Pyramid-temples, which immediately adjoined the Pyramids and were approached from the valley by an imposing portal with a causeway behind it. In the xviiiith Dynasty at Thebes the actual burial-place and the buildings devoted to the cult have become completely divorced; the body of the Pharaoh rests in an underground sepulchre far away in a desert wady, while his cult is celebrated in a stately temple near the cultivation. At the same time the religious significance of these funerary temples undergoes a change. They are still the "eternal habitations" of the Pharaohs by and for whom they were constructed, and the "proceSSIONAL statue" (ll. 25-39) of the king is still their principal cult-object; but at the same time they are become temples of the local god, and may fairly be said to have been built by the king "for his father" Amon or Ptah, as the case may be. Administratively, the funerary temples of the Theban period were dependent on the central temple of the place; thus for example the Ramessum is called "the House of Millions of Years of Ramesse-miamun *in the estate of Amon*," and our inscription has an interesting allusion to this affiliation (l. 21).

A point of some importance may here be raised. Amenophis III was buried at Thebes, and his actual funerary temple was actually therefore at Thebes and not at Memphis. From the inscription of our statue however as well as from abundant other sources we have the best of reasons for believing that subsidiary funerary temples were erected at towns very far distant from the actual tomb. The question now arises, does the presence of a funerary temple in a place pre-suppose the existence of a cenotaph corresponding to it in the same place? In other words, is a cenotaph of Amenophis III to be sought somewhere in the Memphitic desert? To this question it is impossible at present to give an answer, but it may be pointed out that such cenotaphs are known, for it has been made pretty certain that the Osireion at Abydos was nothing else than a cenotaph of the kind.

We may pass over the description of the building

of the temple "United with Ptah" (ll. 13-18). There is nothing to show whether the shrine was a large or a small one; Egyptian grandiloquence leaves no room for deductions on such points. In ll. 18-19 we are told that Amenophis III established a regular priesthood in the temple, and endowed it with estates and cattle, as well as a numerous *personnel* for the management of the same; and the whole foundation was placed under the control of the Royal Stewards (l. 21).

48. In the next lines the Chief Steward Amenhotep refers to a private foundation of his own (ll. 22-24). Out of the possessions which he had received as a reward from the Pharaoh he set aside a considerable area of land, together with its serfs and stock, to provide offerings for the statue of his Royal master in "United with Ptah." Later on we learn that this endowment was not inspired solely by motives of gratitude or reverence (ll. 25 foll.), but was part of a bargain according to which Pharaoh undertook to give Amenhotep the benefit of certain daily offerings previously laid before his own statue, after these same offerings had still earlier been placed before the image of the god Ptah. We have thus a quite complicated transaction to deal with here. Pharaoh has rewarded Amenhotep with lands, and in return Amenhotep institutes offerings for the statue of Pharaoh. Before the statue of Pharaoh can enjoy them however, they have to pass before the image of Ptah, who first of all "sates himself with them." Next, the statue of Pharaoh makes a meal of them; and finally, by compact with the Pharaoh, they are handed to the lector-priest who attends to Amenhotep's funerary cult to be laid before Amenhotep's statue in his tomb. The ultimate beneficiary was "the lector-priest in Amenhotep's estate"

himself (ll. 26, 47), who was thus provided with his means of subsistence.

Agreements of a similar kind have long been known; those recorded in the tomb of Hep-zefi at Siut are the most familiar example. Nothing quite as intricate as the present instance has perhaps been found hitherto. That such agreements should have existed is based on the material fact that statues, whether of stone or of wood, of gods or of men, cannot actually consume the offerings that are placed before them; whence it follows that the same offerings may serve for the performance of several consecutive ceremonial sacrifices. On the spiritual side, there was also thought to be a special sanctity about food that had served the god for a meal; and the most familiar prayer of the Egyptian was that he might enjoy "offerings that had gone up on the altar of the great god," "after the god had been satisfied with his possessions." The practical difficulty was always as to the final human beneficiary. In the present case there were many persons who would have an interest in preventing the offerings in question from ever reaching Amenhotep's lector-priest. In the first place there were the Royal Stewards who administered the temple "United with Ptah," and then all the numerous hungry priests and temple-servants who attended to the needs of Ptah and of the statue of Amenophis III. The Royal Scribe Amenhotep had himself, evidently, no very sure confidence that the arrangement he had made would be carried out; for at the end of his inscription he uses the familiar device of blessing the observer of his wishes and cursing him who should transgress them, at the same time pleading that his virtue in life merited proper recognition after his death.

INDEX

- Adze, copper, 8, 9, 11, 13, 15, 23
 Ain, white stone of, 34
 Alabaster vases figured, 18, 21
 Amenemhat III at Memphis, 32
 Amenhotep, scribe, figure of, 33-36
 Amenhotep III, temple of, 33, 35
 Armlets of copper, 23
 flint, 11, 22
 horn, 10, 11, 12
 horn and copper, 10, 22, 23
 ivory, 10, 22
 limestone, 22
 shell, 8, 22
 slate, 10, 11, 12, 22
 Arrow-heads, 8, 25
 Ashes in jars, 8, 9, 12
 absent from great mastaba, 18
 Axe, copper, 8, 23

 Ball of rag and cord, 25
 Basket, 10, 11, 25
 Basket burials, 6, 8, 11, 13, 27
 Beads, 11
 threaded on cloth, 22
 Beds, burial of, 6, 8, 9, 10, 11
 construction of, 23, 24
 Beetles buried, 11, 22
 Bow, tip of, 13
 Bowl of wood, 25
 Bracelets, see Armlets
 Bricks, sizes of, 8, 9, 11, 13, 14
 Bucranion of the Fayum, 22
 Bull's legs carved, 10, 25
 Burials described, 26

 Carpentry, 10
 Cemetery plans, 29, 30
 Changes during first dynasty, 5-7
 Charcoal buried in dishes, 11

 Chisels, copper, 8, 23
 Civilisation, prehistoric, compared with historic, 19, 20
 Classifying of material, 3
 Coffin cut in one block, 10, 26
 of house type, 27
 of matting, 9
 of wood, 6, 9, 10, 11, 12, 22, 27
 types of, 6, 22, 27
 Comb of ivory, 12, 22
 Contraction of body, extreme, 11, 13
 Copper bowls, 9, 23
 model tools, 9
 spear-head, 10, 21
 tools, 7, 8, 9, 11, 13, 15, 17, 23
Corpus, conversion of Dr. Junker's, 4
 early dynastic, 1, 2, 28
 necessity of, 4, 7
 prehistoric, 1
 series, 2
 Crocodiles on seal, 22
 Cubit used in mastaba, 15
 Cylinder jars, grouping of, 2

 Dagger of wood, 9, 21, 25
 Dating of mastaba, 16
 system, 3, 4
 Dipper of wood, 8, 25
 Direction of head and face, 5
 Dismembered skeleton, 13, 26, 27
 Draughtsmen, ivory, 15, 17, 25, 26
 Drawings of types necessary, 4
 Dynasty, cemetery of first, 1

 Elverson, Mr., 1
 Engelbach, Mr., 1, 11, 23, 30

 Face, direction of, 5
 Fat, scented, 9, 11, 12

- Fayum seal, 21
 Fender wall, 13
 Fire offering, 11
 First dynasty cemetery, 1
 styles of, 2
 Fish palette, 8, 21
 Flaying knives, 23
 Flint flakes, 16
 knife, 8, 12, 23
 Foreign pottery, 16-18
- Galena, 8
 Gaming pieces, 25, 26
 Gardiner, Dr. Alan, chapter by, 33-36
 Gau, cedar of, 34
 Gazelle skull, 8
 slate, 21, 27
 Graves, described, 26, 30
 details of type, 8
 register of, 3, 4, 7, 8
 size of, 5, 6
 with objects published, 31
- Hairpins, ivory, 26
 Head, direction of, 5
 Head-rest, 13
 Heliopolis, work at, 1
 Herodotos, accuracy of, 32
 House imitated in coffin, 27
 timbers, 9, 12, 22, 24
- Ivory comb, 12, 22
 cylinder jar, 11
 spoon, 8, 9, 10, 25
 carved, 25
- Junker Dr., *Bericht*, 4
 publication of work, 7, 29
- Ka, king, 8, 9, 21, 26
Ka da name, 12, 22
 Kafr Ammar, site, 1
- Lawrence, Mr., 1
- Mackay, Mr., 1, 22, 30
 Malachite, 8, 9
 Marks on pottery, 28
 Mastaba 1060, of Senar, 13-18
- Mat lining of graves, 9, 12
 Matting, ancient and modern, 25
 Memphis, sculptures from, 32
 work at, 32
 Mud box, 18
 coffin, 26
 in jars, 8
 Multiple burial, 13
 Museums receiving objects, 30
- Naga ed Deir cemetery, 4, 8
 Narmer, 11, 21, 26
 Narmer-tha, 9, 21
 North gate of Ptah temenos, 32
 wall of Memphis temenos, 32
- Offering chambers, 12
 Offerings, transference of, 34, 36
- Palette, hollowed form, 21, 27
 Panelled pattern, origin, 23
 Photographs inferior to drawings, 4
 Pilgrim bottle, 21
 Plans of cemetery, 29, 30
 Pot-marks, 28
 Pottery, changes in first dynasty, 17-19
 classification of, 2, 28
 coffin, 13
 foreign, 16-18
 Ptah figure on bowl, 12, 22
- Quartz bowl, 15, 18
- Ramessu II and Osiris, group, 33
 and Ptah, group, 32
 granite sphinx, 33
 Red paint on doorways, 13, 14, 18
 Reed-basket coffin, 6, 9, 27
 Register of graves, 3, 4, 7, 8, 29
 Reisner, Dr., 4, 8, 14, 20, 29
 Roofing of stone, 15
 of wood, 9, 11, 12, 13, 26
 Rope-nets on jars, 9
- Sa amulet case, 12, 22
 Sandal tray, 11, 12, 25
 Sawing of wood, 26
 Scarab-form case, 9, 22
 Scenas Mandras, 1
 Scribe, seated figure of, 33

- Sealings from mastaba, 18
 of Fayum, 21
 of Narmer, 21
- Sebek on standard, 22
- Senar, mastaba of, 13-18
 name of, 18
- Sequence dates in first dynasty, 3
- Shurafeh, Scenas Mandras, 1
- Signs on pottery, 28
- Slate palettes, 8, 27
- Spear-head of copper, 10, 21
- Sphinx of red granite, 33
- Spoon, ivory, 8, 9, 10, 25
 carved, 25
- Stairway tombs, 27
- Stone vases, classification of, 3, 28
- Stool, three-legged, 11
- Straw-plaited mat, 13
- String-bound handle, 23
- Table, wooden, 8, 11, 25
- Tahuti-mer, name of, 9
 tomb of, 26
- Tarkhan cemetery, date of, 1
- Tarkhan, site of, 1
- Tray of wood, 8, 25
- Trays for burial, 6, 10, 11
- Turah cemetery, 4
- Turtle palette, 8, 21
- View of Tarkhan, 20
- Wainwright, Mr., 1, 30
 chapter by, 13-20
- Walking-sticks, 24
- Wavy-band, 21
- Wooden chisels, 25, 26
 coffins, 6, 9, 10, 11, 22
 dagger, 9, 21
 floor of recess, 13
 hoes, 26
 houses, 24
 shadūf hooks, 25
 vessels, 8, 11, 25
- Zebra, half of, drawn, 9, 22

WORKS BY W. M. FLINDERS PETRIE

- THE PYRAMIDS AND TEMPLES OF GIZEH. (Out of print.)*
TANIS I. 19 pl., 25s. *Quaritch.*
TANIS II. Nebesheh and Defenneh. 64 pl., 25s. *Quaritch.*
NAUKRATIS I. 45 pl., 25s. *Quaritch.*
HIEROGLYPHIC PAPYRUS FROM TANIS. (Out of print.)
A SEASON IN EGYPT, 1887. 32 pl. (Out of print.)
RACIAL PORTRAITS. 190 photographs from Egyptian Monuments. (To be printed, 1913.)
HISTORICAL SCARABS. (Out of print.)
HAWARA, BIAHMU, AND ARSINOE. (Out of print.)
KAHUN, GUROB, AND HAWARA. (Out of print.)*
ILLAHUN, KAHUN, AND GUROB. 33 pl., 16s. (Out of print.)*
TELL EL HESY (LACHISH). 10 pl., 10s. 6d. *Alexander Watt.*
MEDUM. 36 pl. (Out of print.)
TEN YEARS' DIGGING IN EGYPT, 1881-1891. 6s. *R.T.S.*
TELL EL AMARNA. (Out of print.)
KOPTOS. 28 pl., 10s. *Quaritch.*
A STUDENT'S HISTORY OF EGYPT. Part I., down to the XVIth Dynasty. 5th ed. 1903. Part II., XVIIth and XVIIIth Dynasties. Part III., XIXth to XXXth Dynasties. 6s. each. *Methuen.*
TRANSLATIONS OF EGYPTIAN TALES. With illustrations by Tristram Ellis. 2 vols., 3s. 6d. each. *Methuen.*
DECORATIVE ART IN EGYPT. 3s. 6d. *Methuen.*
NAQADA AND BALLAS. 86 pl., 25s. *Quaritch.*
SIX TEMPLES AT THEBES. 26 pl., 10s. *Quaritch.*
DESHASHEH. 37 pl., 25s. *Quaritch.*
RELIGION AND CONSCIENCE IN EGYPT. 2s. 6d. *Methuen.*
SYRIA AND EGYPT. 2s. 6d. *Methuen.*
DENDEREH. 38 pl., 25s.; 40 additional plates, 10s. *Quaritch.*
ROYAL TOMBS OF FIRST DYNASTY. 68 pl., 25s. *Quaritch.*
DIOSPOLIS PARVA. 48 pl. (Out of print.)
ROYAL TOMBS OF EARLIEST DYNASTIES. 63 pl., 25s.; 35 additional plates, 10s. *Quaritch.*
ABYDOS. Part I. 81 pl., 25s. *Quaritch.*
ABYDOS. Part II. 64 pl., 25s. *Quaritch.*
METHODS AND AIMS IN ARCHAEOLOGY. 66 blocks, 6s. *Macmillan.*
EHNASYA. 25s. *Quaritch.*
ROMAN EHNASYA. 10s. *Quaritch.*
RESEARCHES IN SINAI. 186 illustrations and 4 plans, 21s. *John Murray.*
MIGRATIONS. Huxley Lecture, 1906. 11 pl., 2s. 6d. *Anthropological Institute.*
HYKSOS AND ISRAELITE CITIES. 40 pl., 25s. *Quaritch.* (With 48 extra plates, 45s., out of print.)
RELIGION OF ANCIENT EGYPT. 1s. *Constable.*
GIZEH AND RIFEH. 40 pl., 25s.; with 69 extra plates, 50s. *Quaritch.*
ATHRIBIS. 43 pl., 25s. *Quaritch.* (Out of print.)
PERSONAL RELIGION IN EGYPT BEFORE CHRISTIANITY. 2s. 6d.; in leather, 3s. 6d. *Harper.*
MEMPHIS I. 54 pl., 25s. *Quaritch.*
QURNEH. 56 pl., 25s. *Quaritch.* (Out of print.)
THE PALACE OF APRIES (MEMPHIS II). 35 pl., 25s. *Quaritch.*
ARTS AND CRAFTS IN ANCIENT EGYPT. 45 pl., 5s. *Foulis.*
THE GROWTH OF THE GOSPELS. 2s. 6d. *Murray.*
MEYDUM AND MEMPHIS III. 47 pl., 25s. *Quaritch.*
EGYPT AND ISRAEL. 54 figs. 2s. 6d. *S.P.C.K.*
HISTORICAL STUDIES. 25 pl., 25s. *Quaritch.*
REVOLUTIONS OF CIVILISATION. 57 figs. 2s. 6d. *Harper.*
THE FORMATION OF THE ALPHABET. 9 pl., 5s. *Quaritch.*
ROMAN PORTRAITS (MEMPHIS IV). 32 pl., 25s. *Quaritch.*
THE LABYRINTH AND GERZEH. 52 pl., 25s. *Quaritch.*
PORTFOLIO OF HAWARA PORTRAITS. 24 col. pl., 50s.
TARKHAN I AND MEMPHIS V. 81 pl., 25s. *Quaritch.*
HELIOPOLIS I AND KAFR AMMAR. *In preparation.*



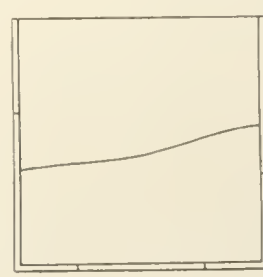
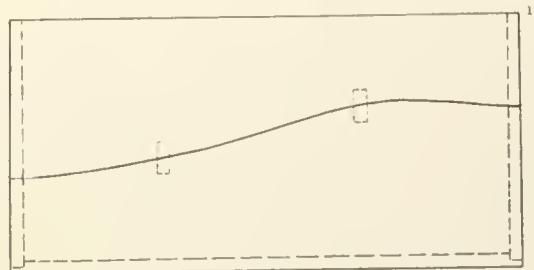
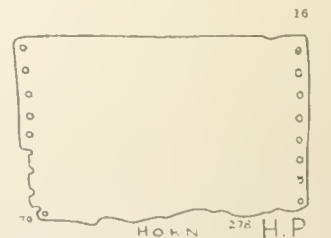
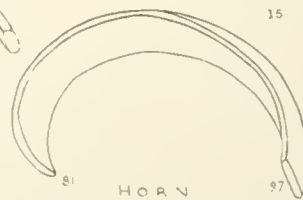
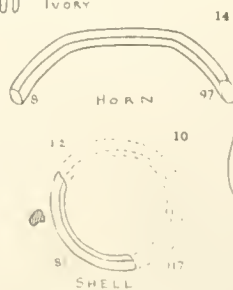
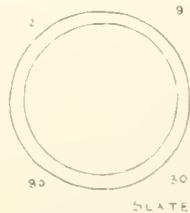
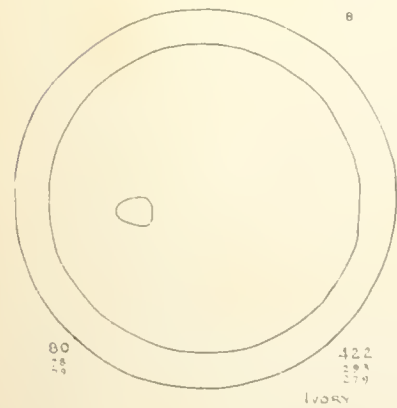
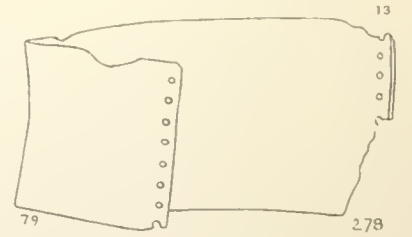
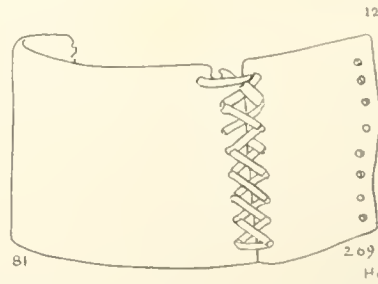
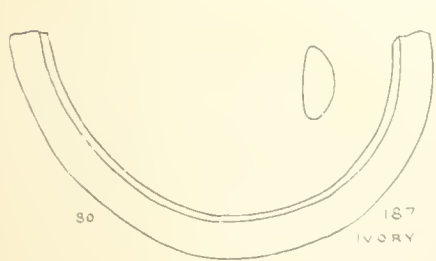
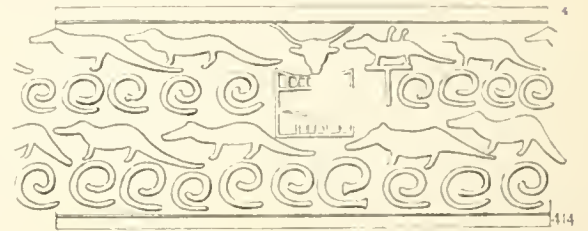
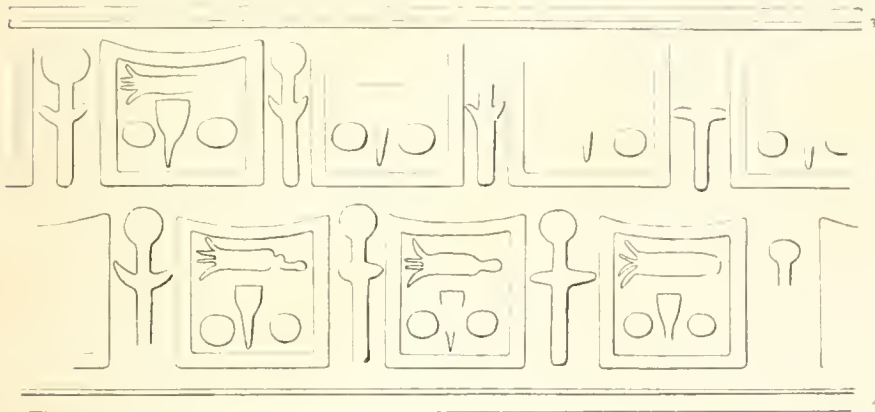
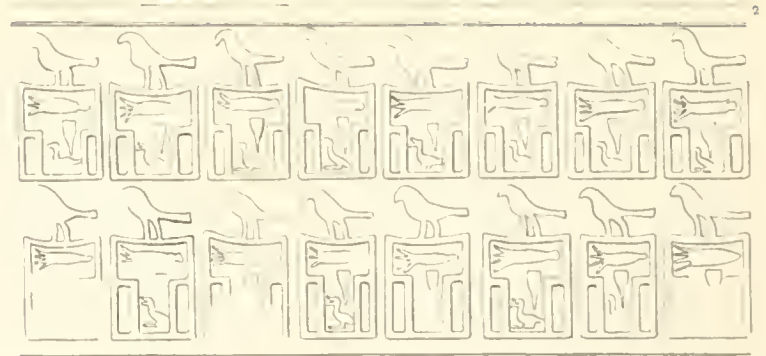
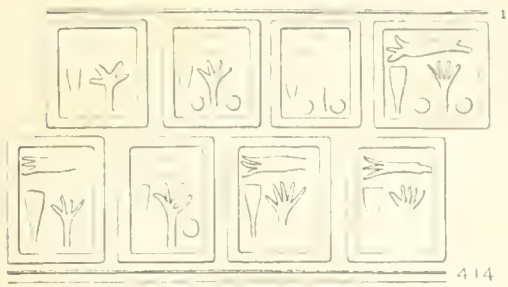

1:30 TYPE OF WOODEN COFFIN. 78-80

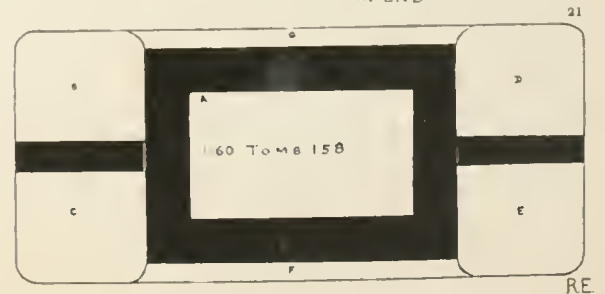
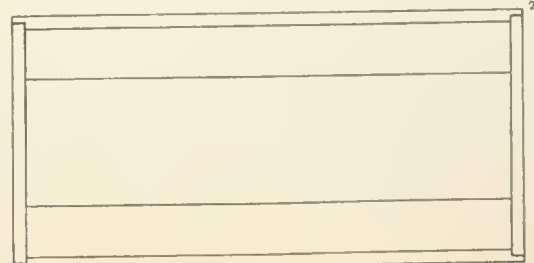
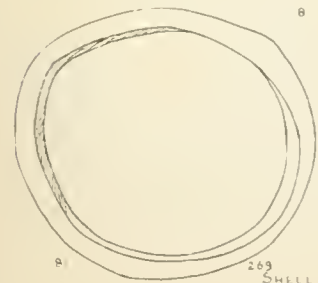



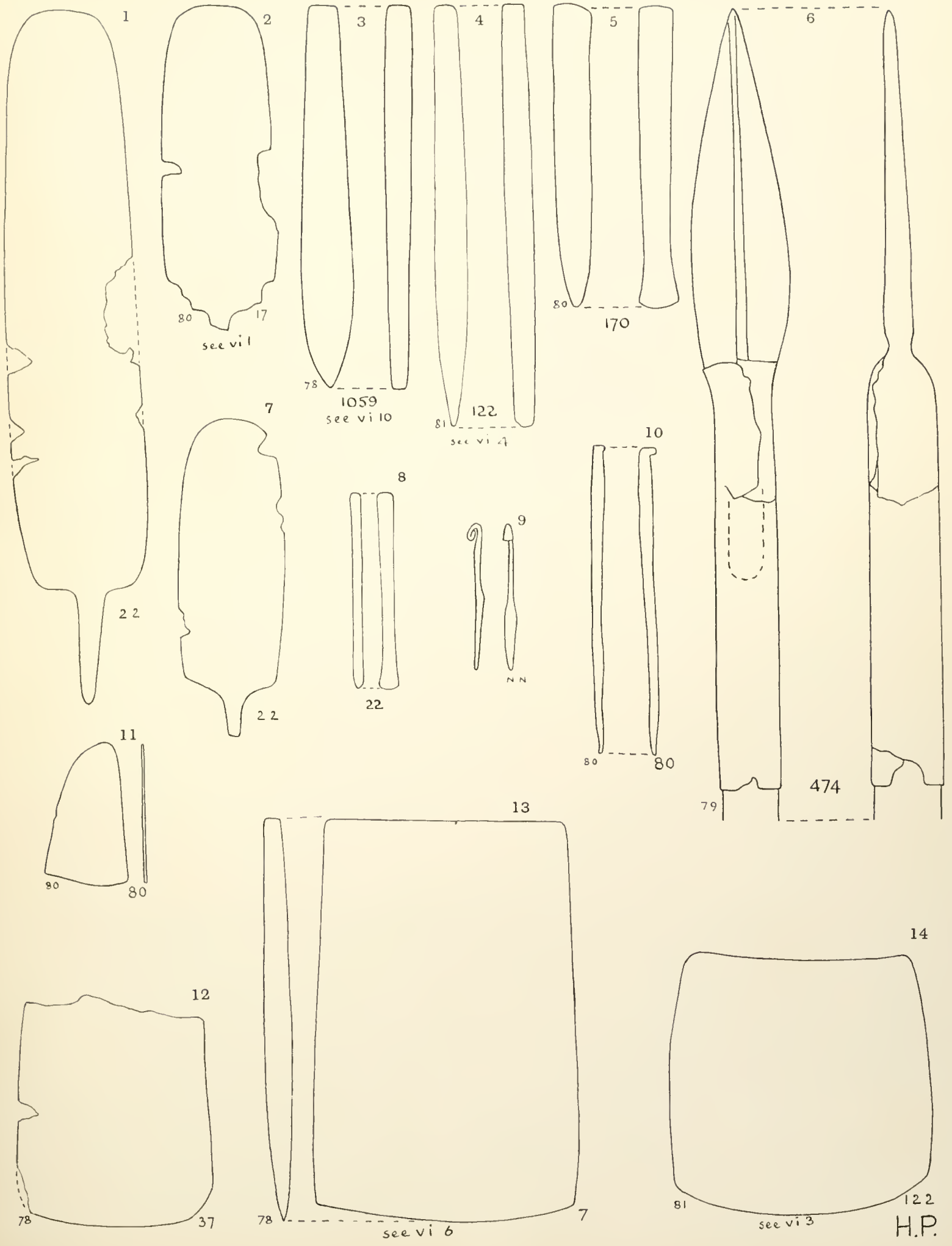

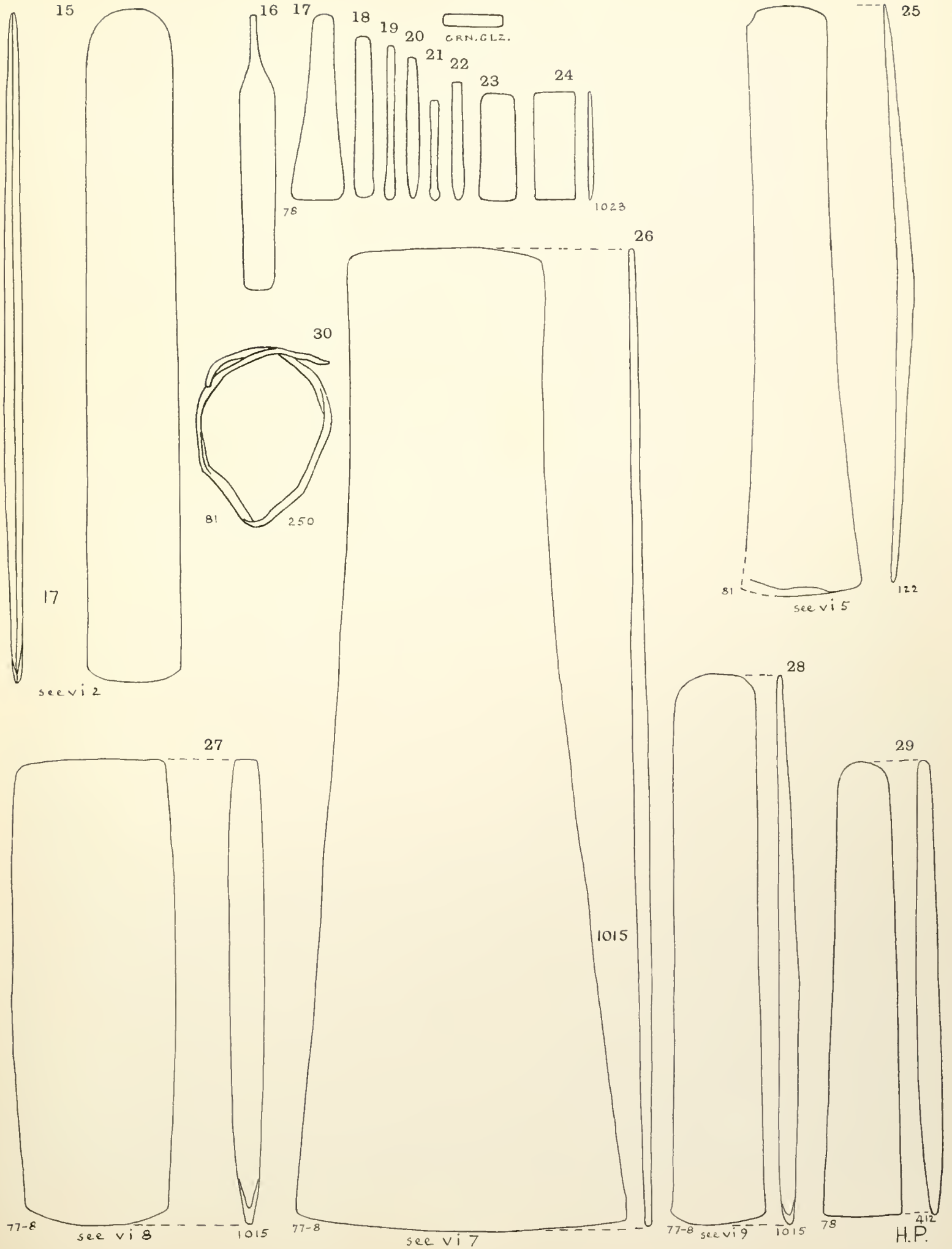





TIP OF BOW



78 336

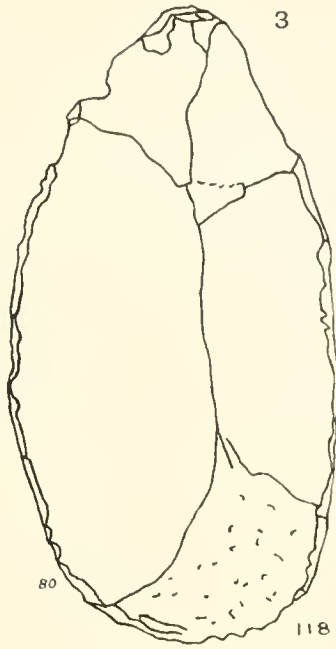

80 118



79 1054

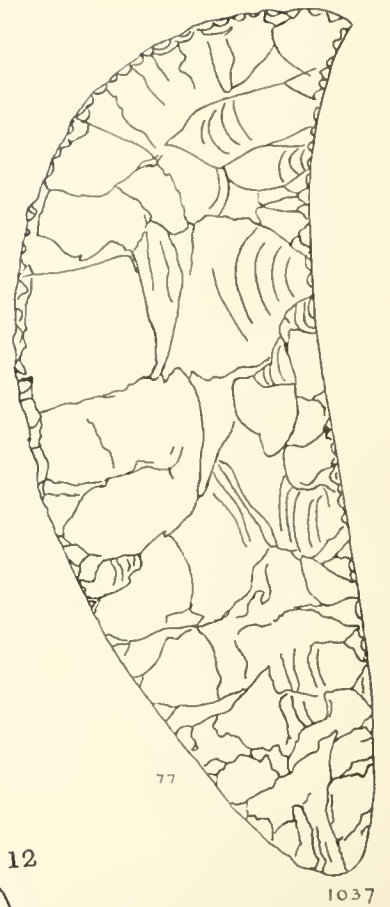

77 1037

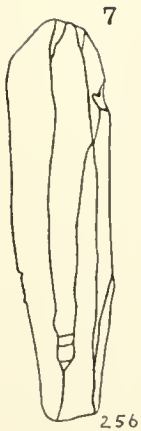

256



77 53

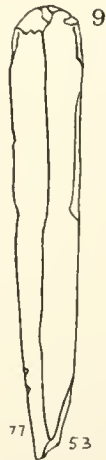

77 53



181

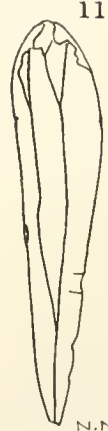

N.N



80 17

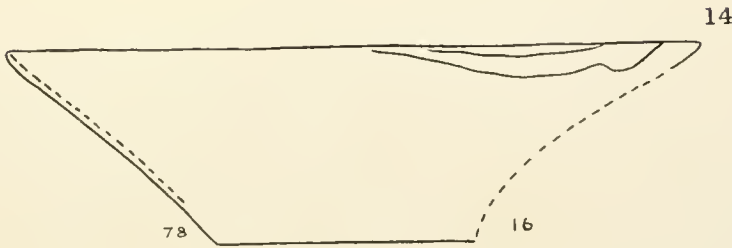

78 16

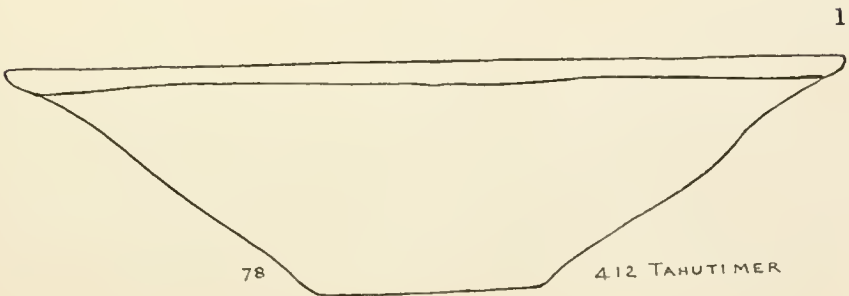

78 412 TAHUTIMER



81 131

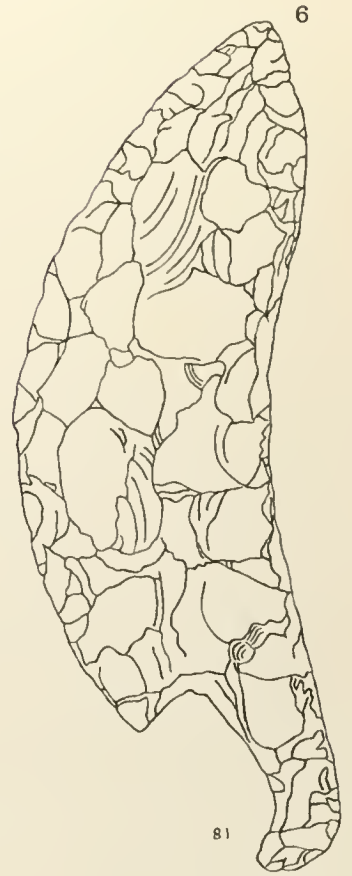

81

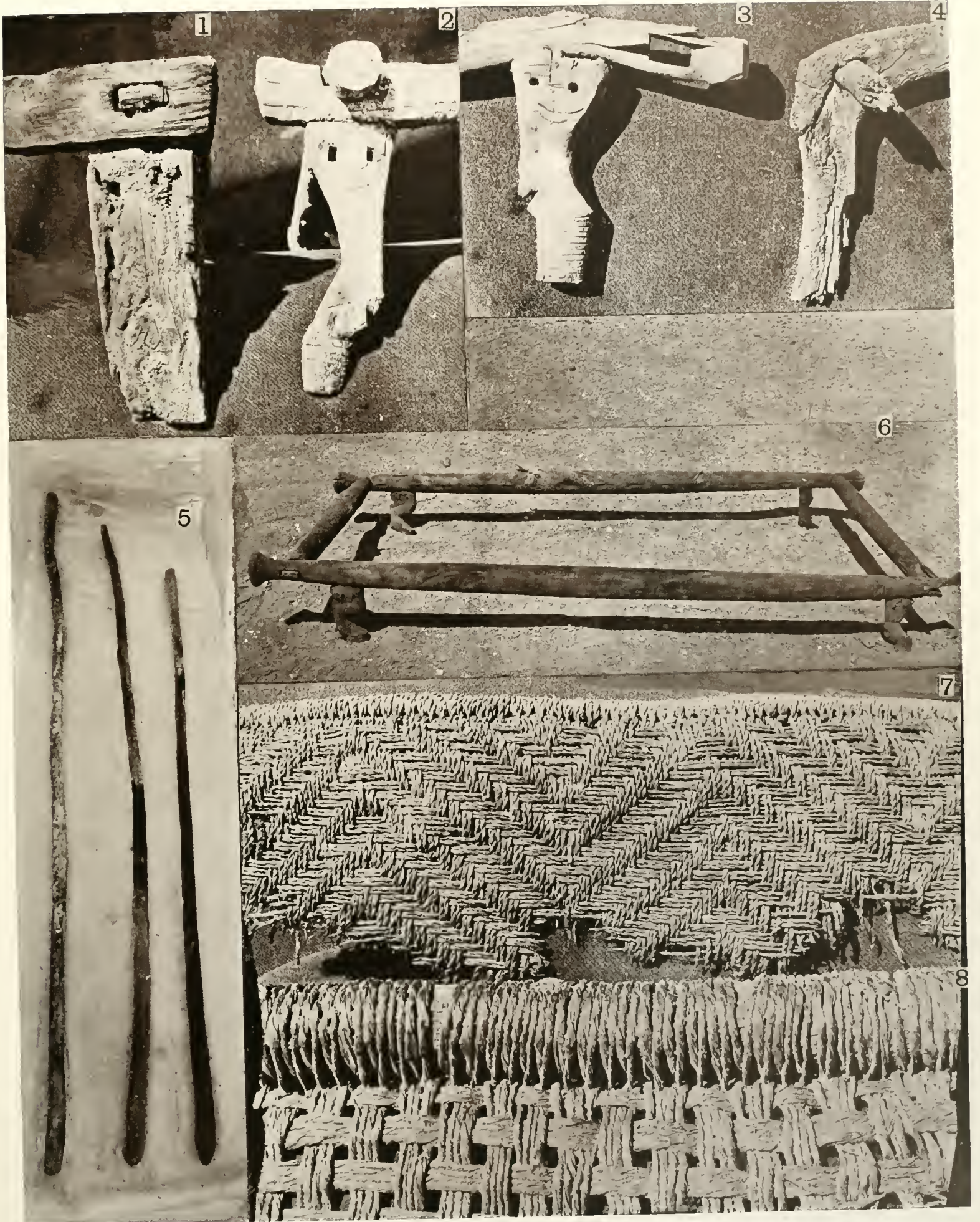

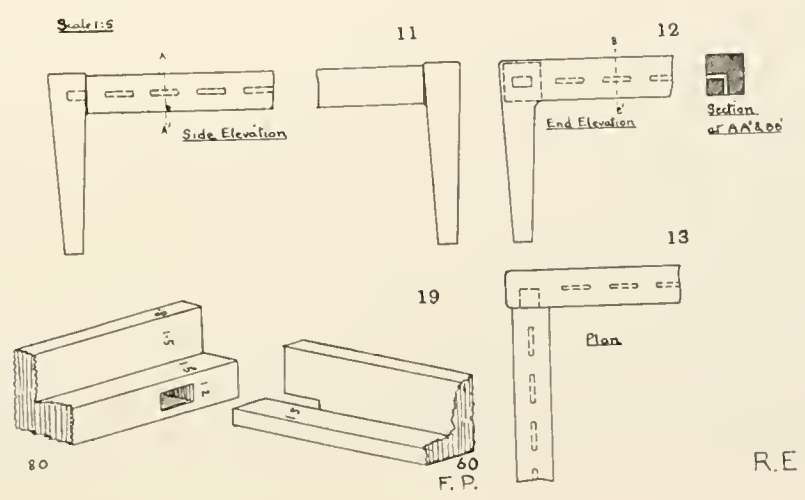
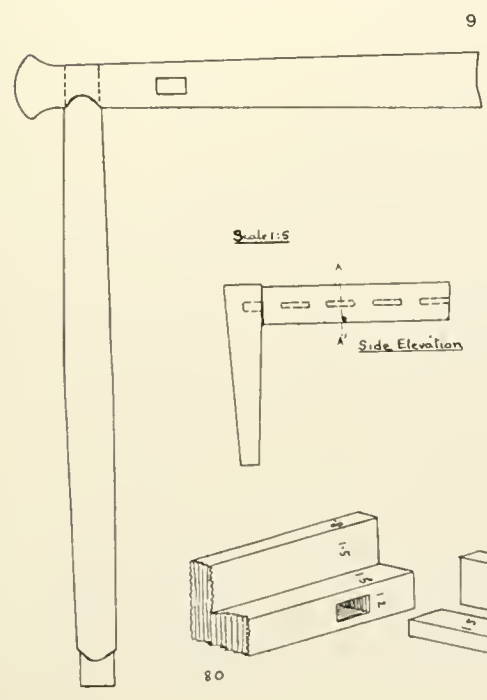
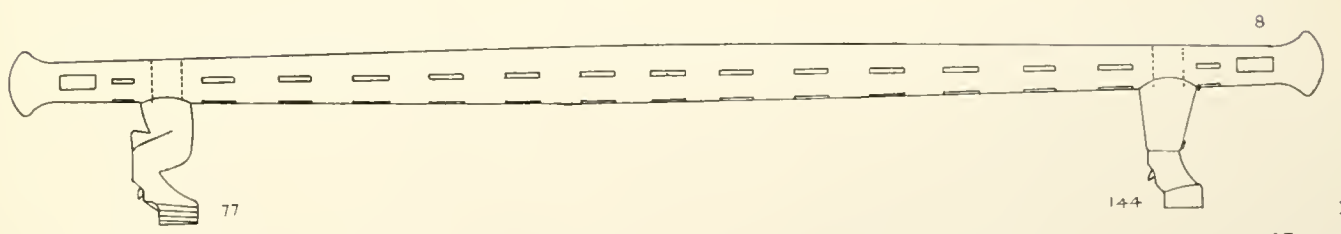
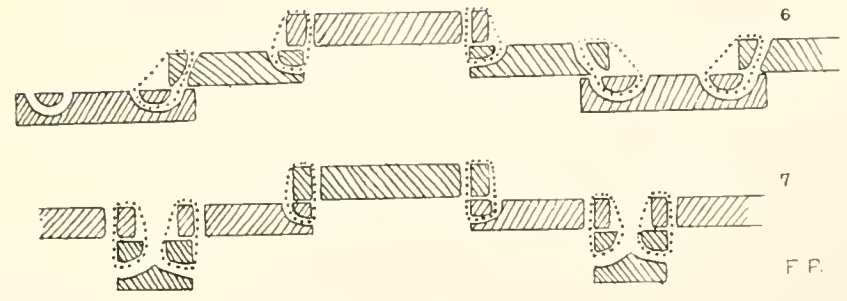
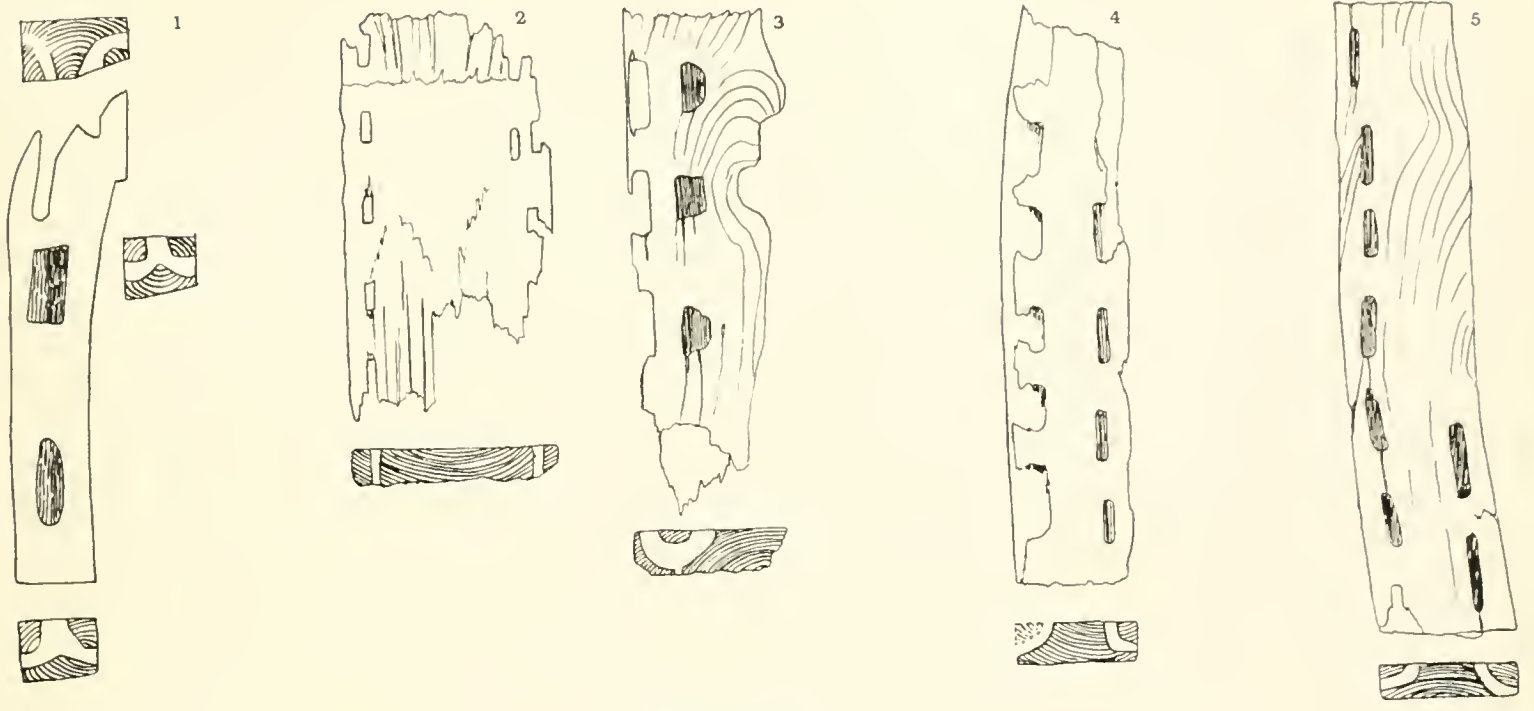



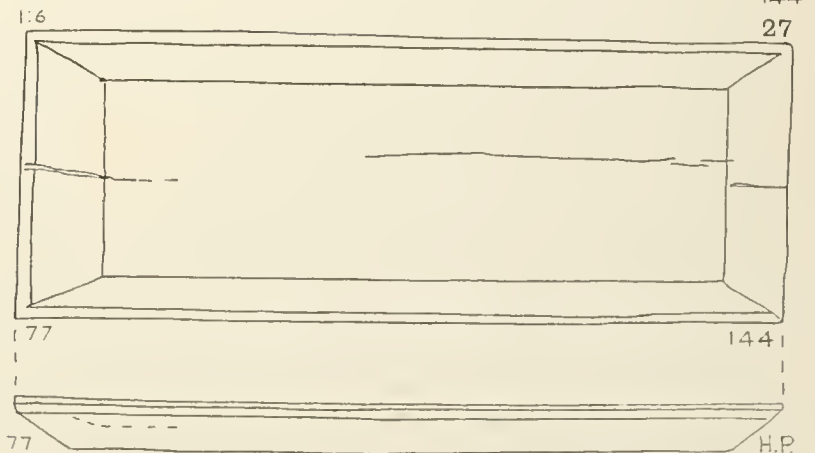
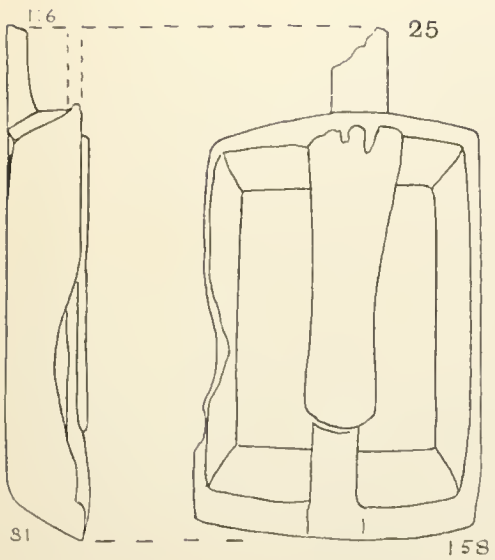
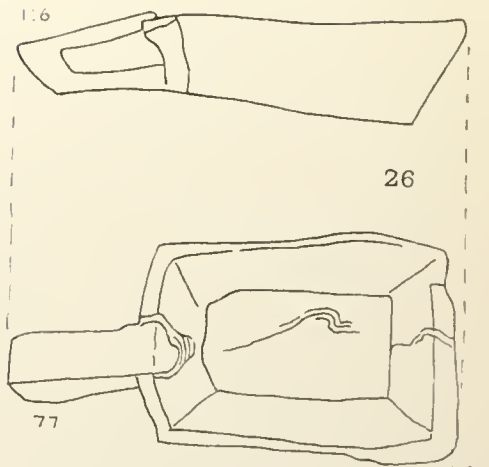
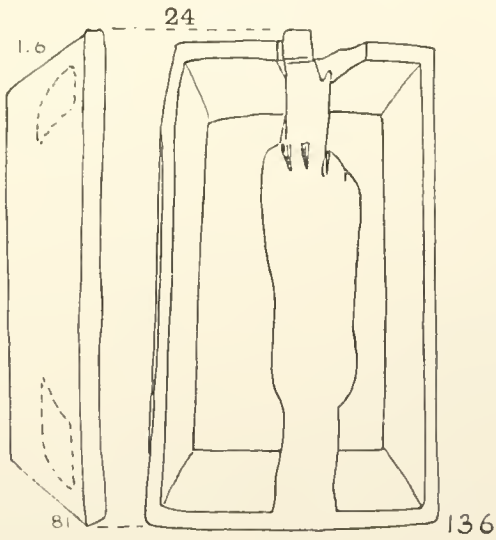
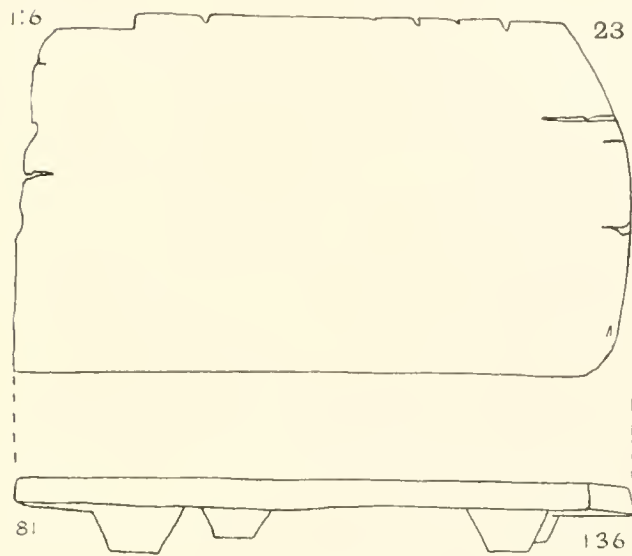
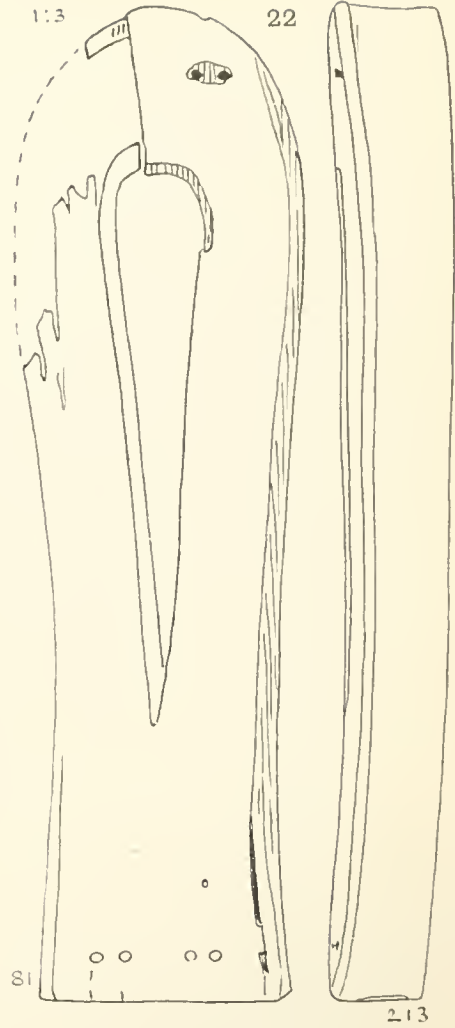
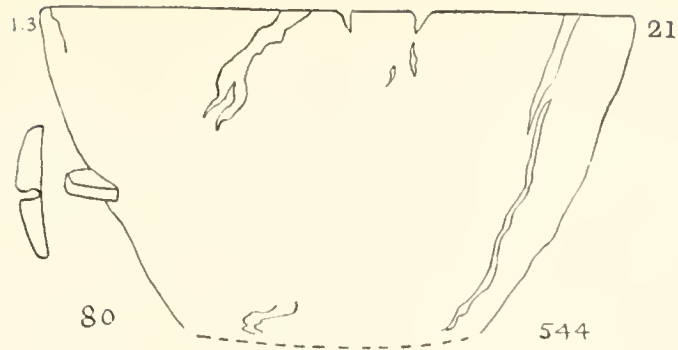
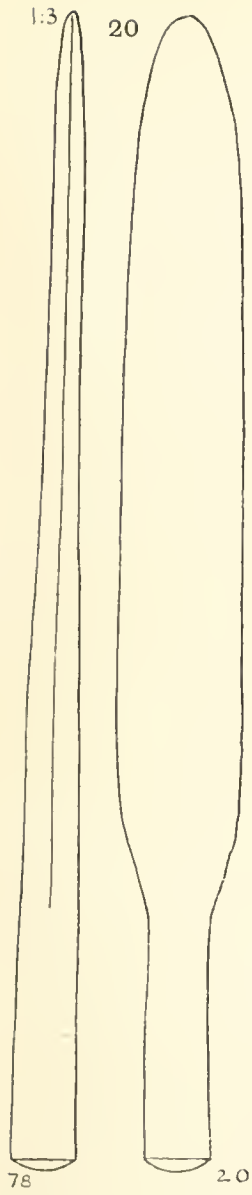



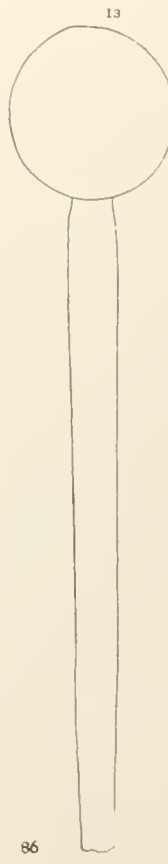
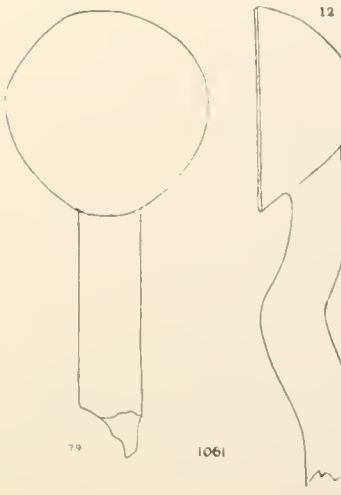
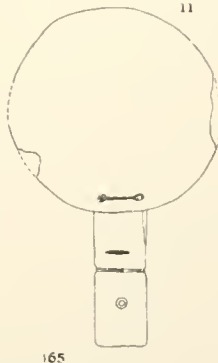
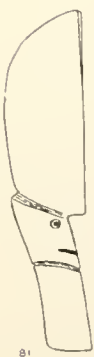
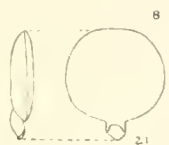
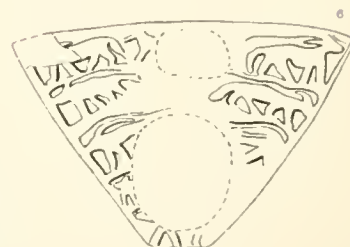
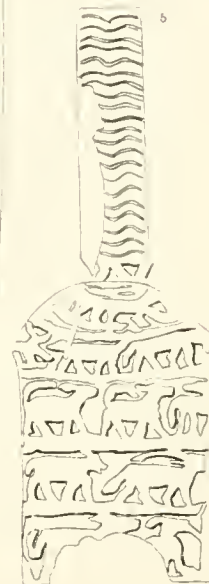
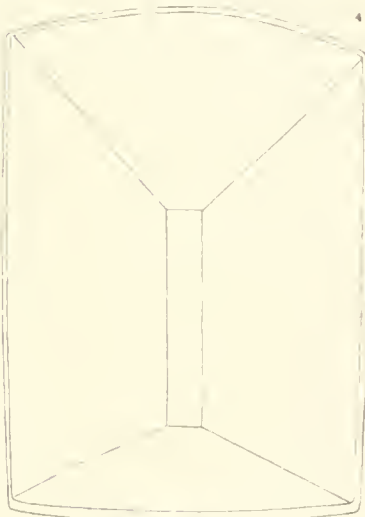
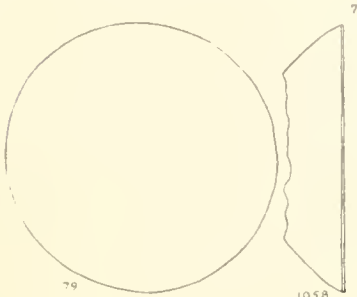
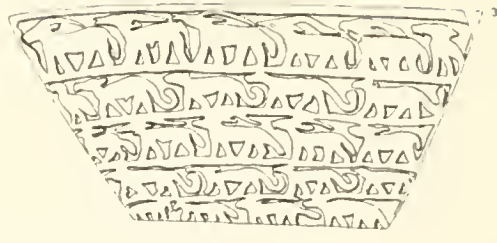
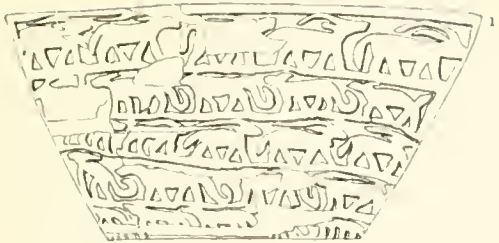

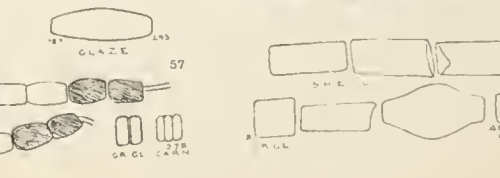
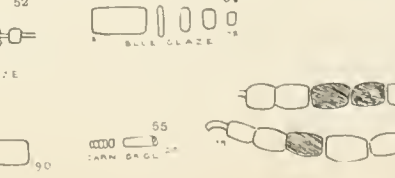
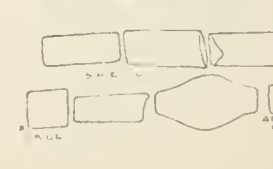
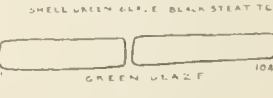
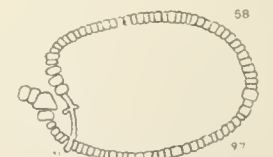
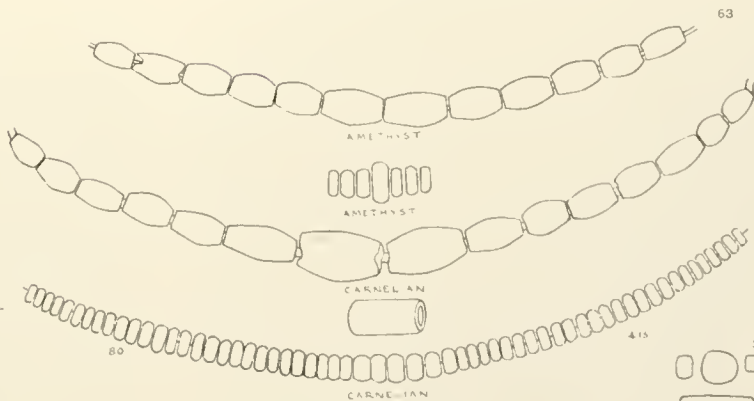
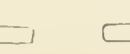
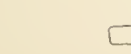
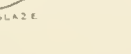
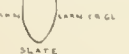
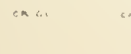
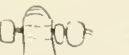
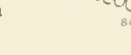
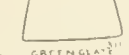
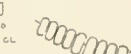
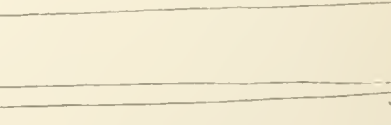
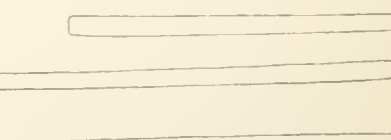
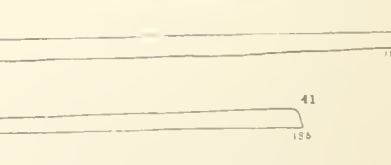
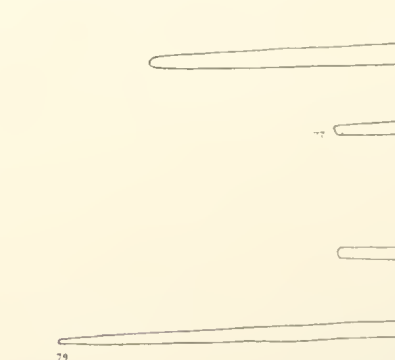
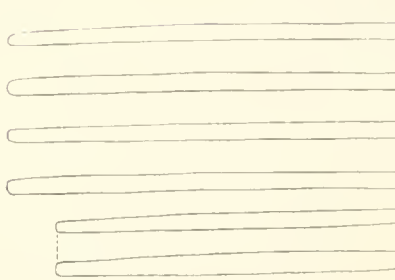
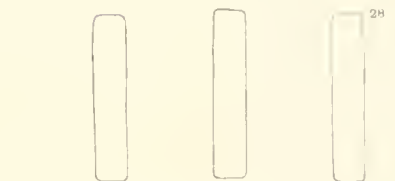
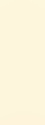
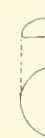
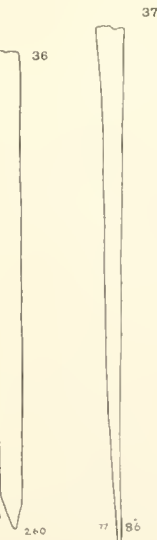
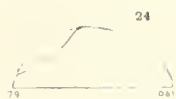
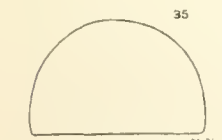
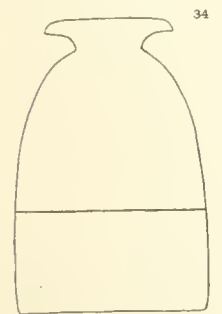
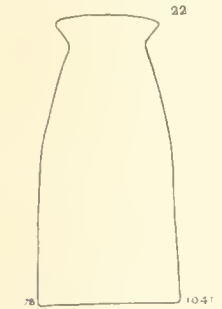
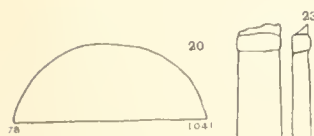
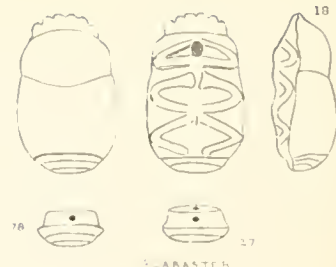
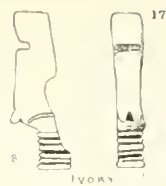
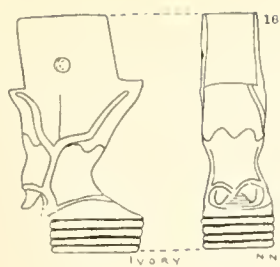



ALABASTER VASES. 1:4.



EASTERN FACE OF MASTABA.



WOODEN FLOOR OF RECESS.



ALABASTER VASES. 1:4.



GROUP OF STONE VESSELS, ETC.



MUD BOX, BOTTOM.

1 : 2

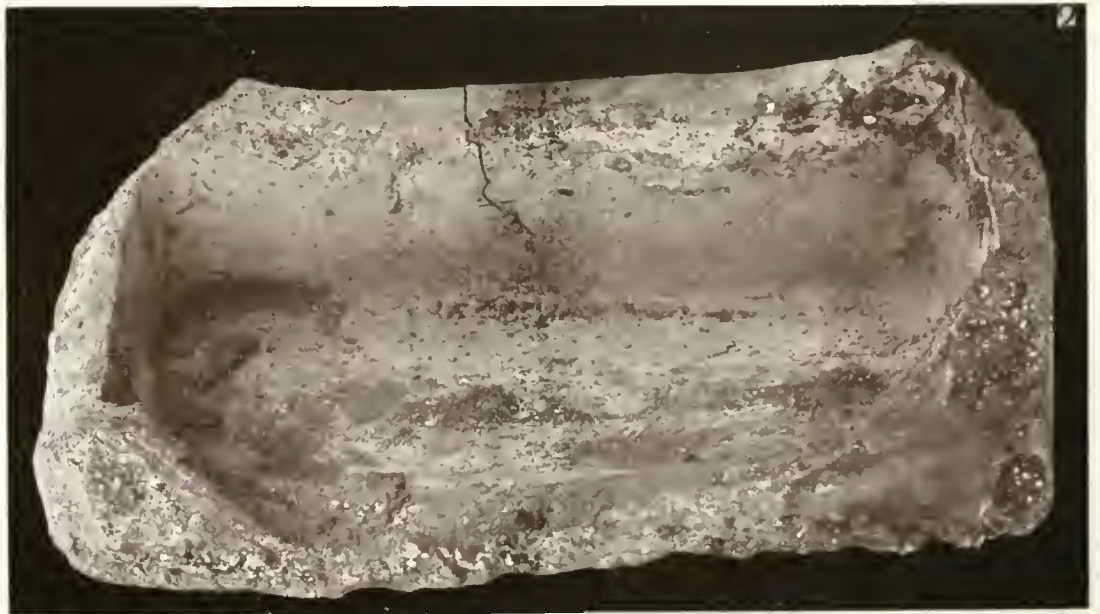

MUD BOX, SIDE VIEW.

1 : 2



ALABASTER VASES.

1 : 4

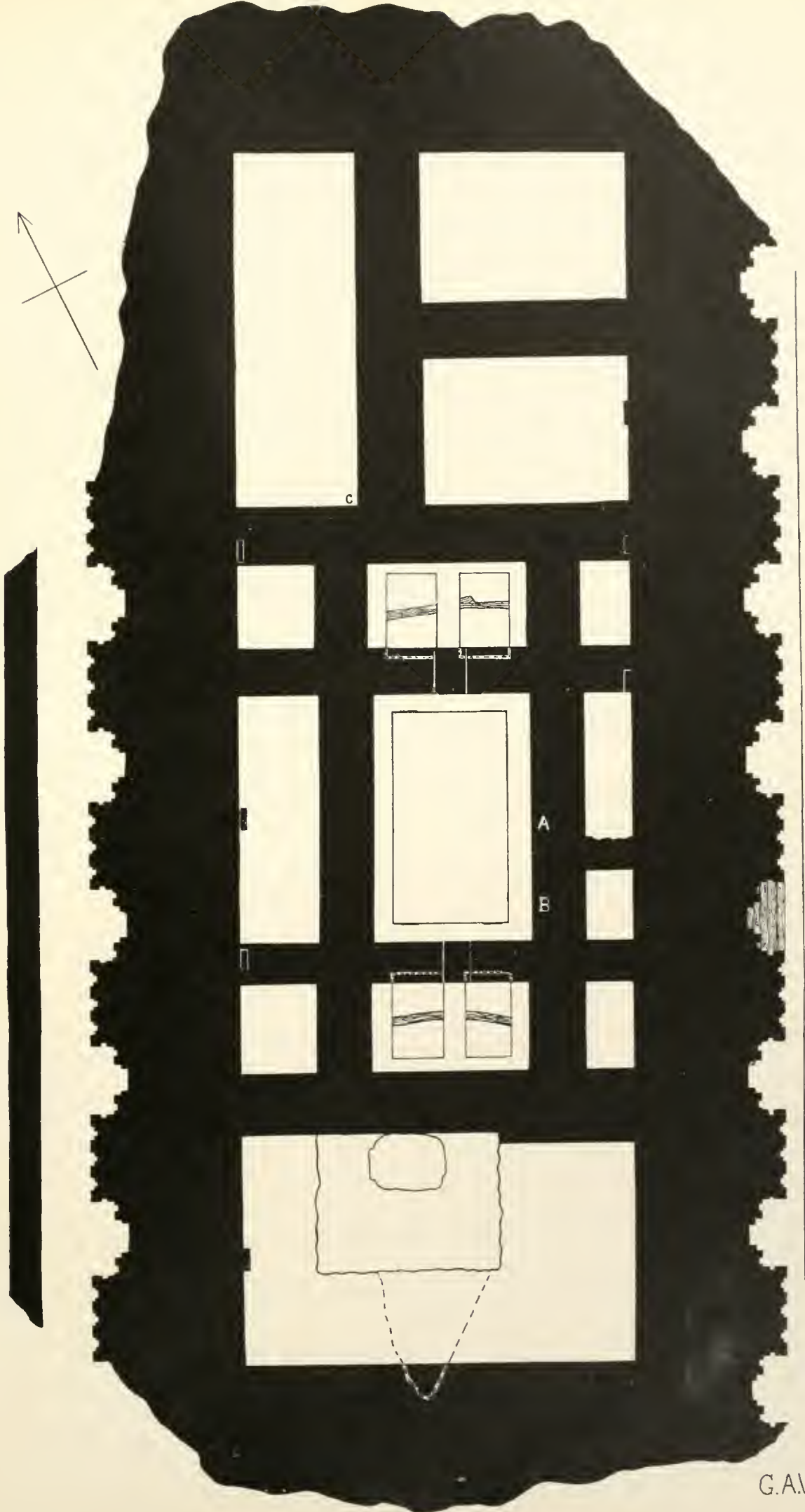

G.A.W.

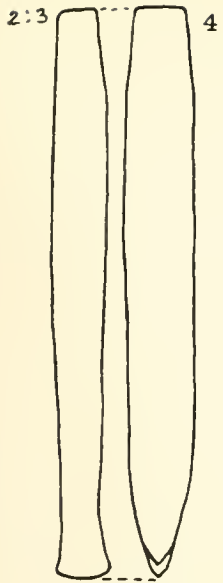

COPPER CHISEL

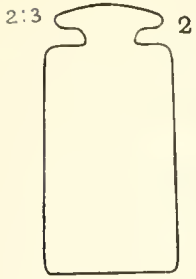

IVORY DRAUGHTSMEN

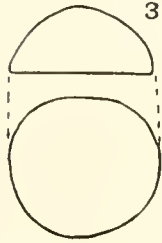

FLINTS.



1:45

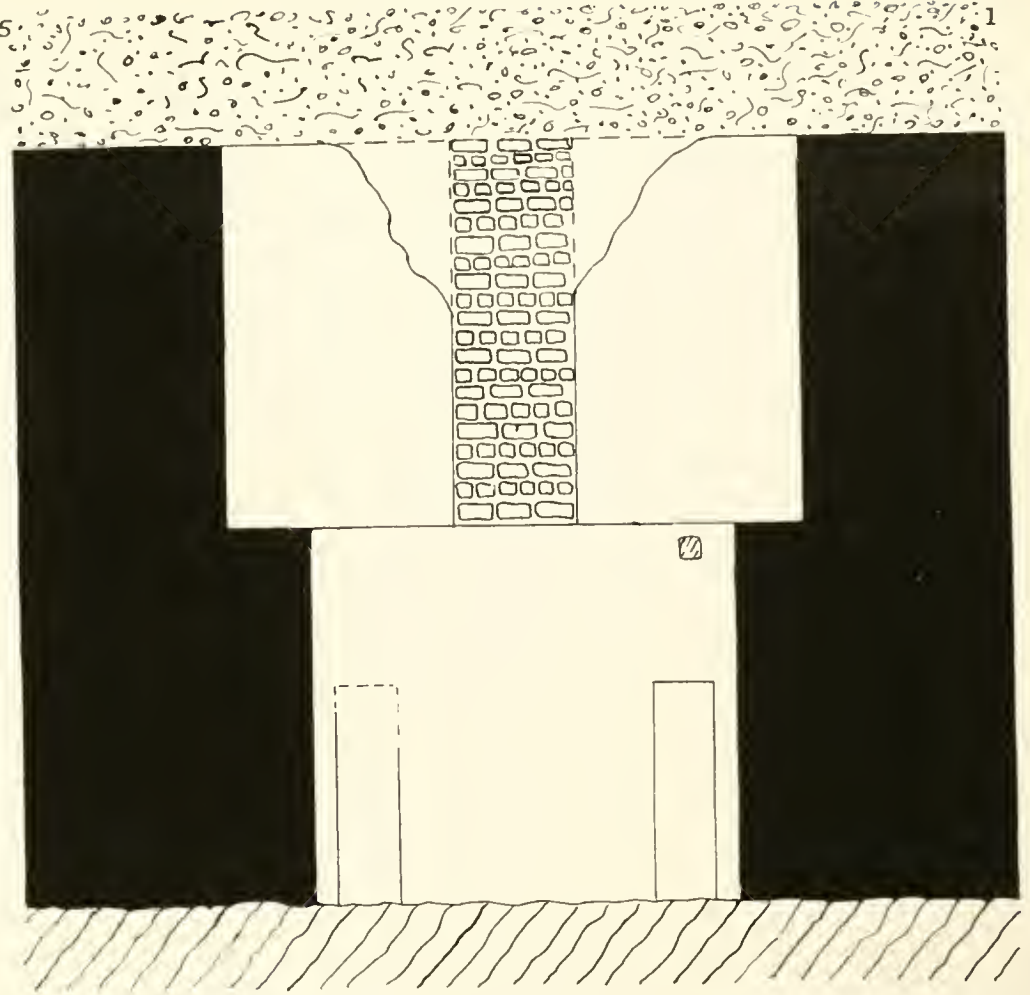

EAST TO WEST SECTION OF CENTRAL CHAMBER.

POTTERY.

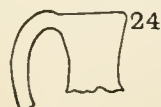
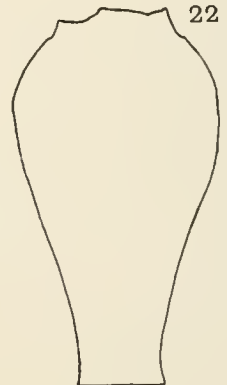
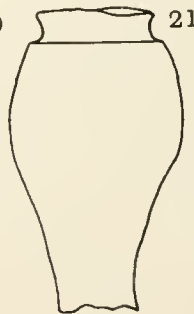
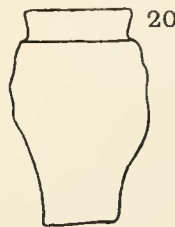
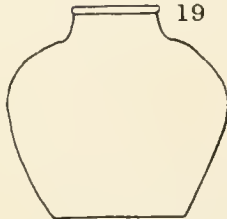
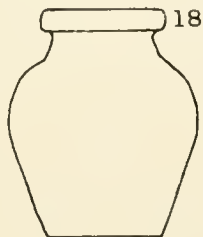
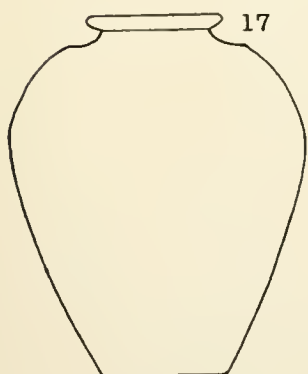
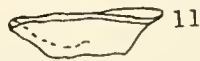
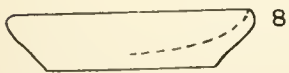
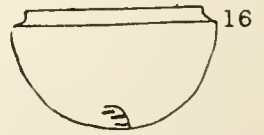
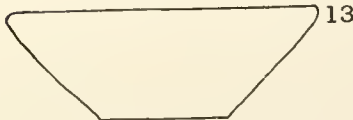
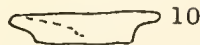
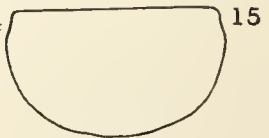
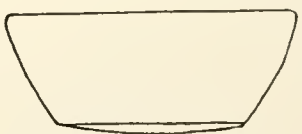
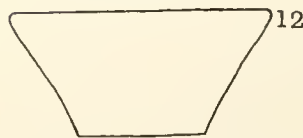
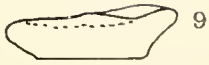
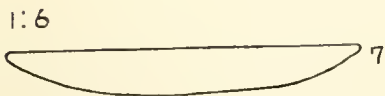

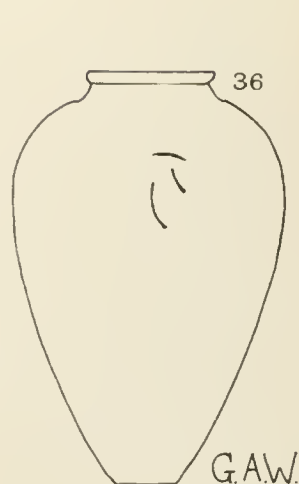
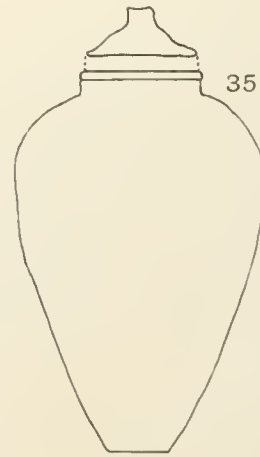
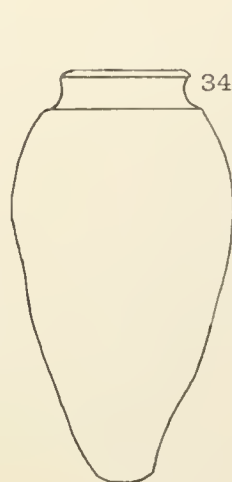
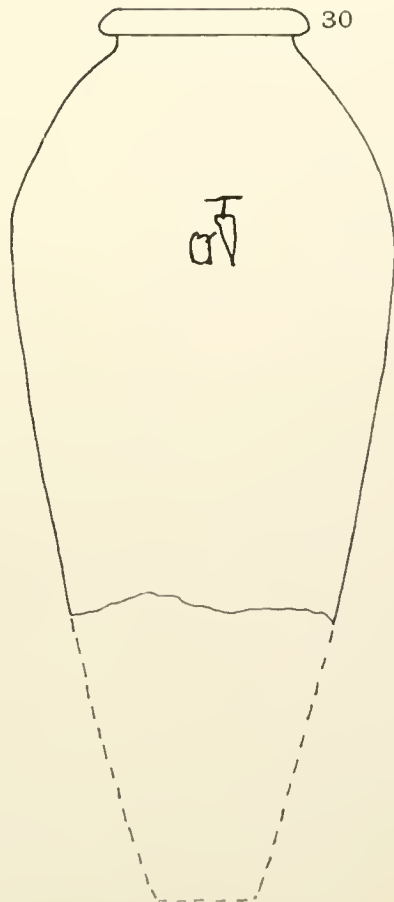
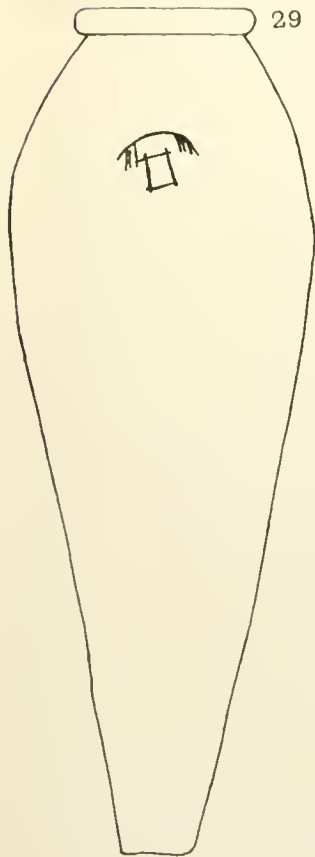
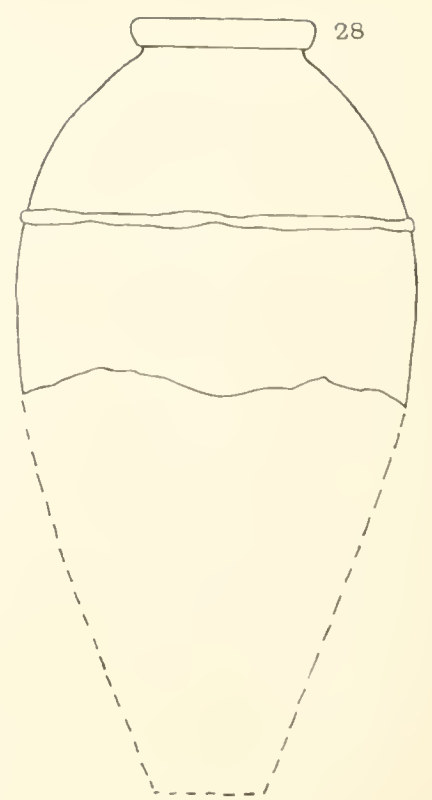
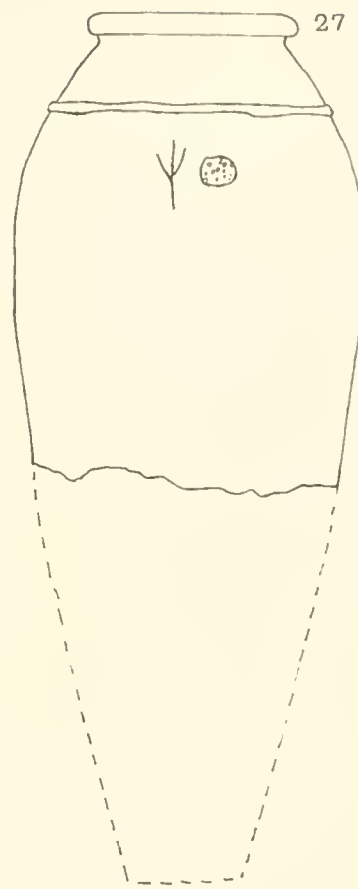
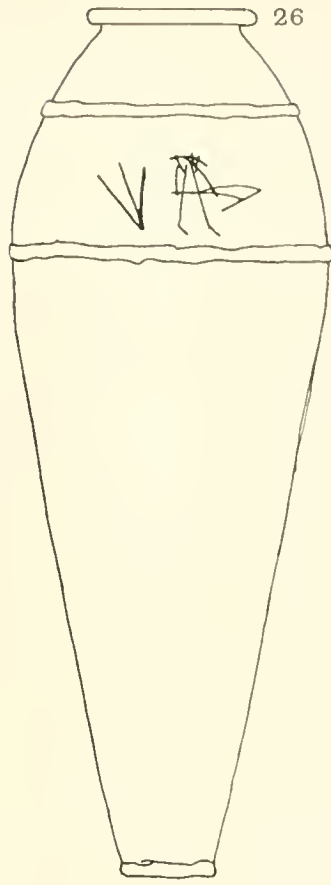
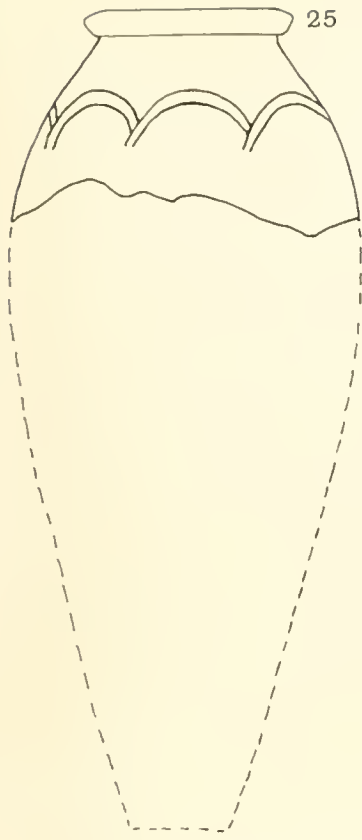

G.A.W.







257



42



3





WITH ENTRANCE BRICKED UP.



BRICKING REMOVED SHOWING COFFIN.

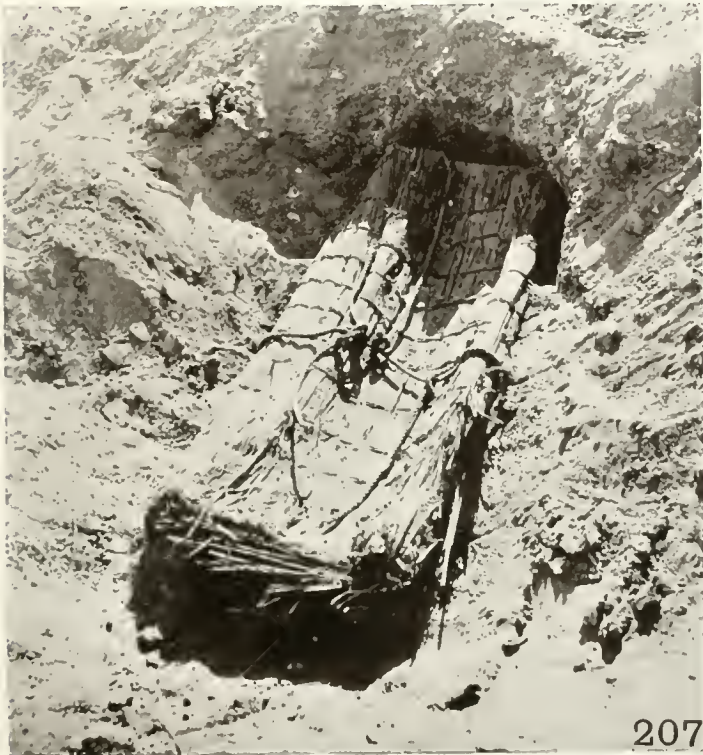

REED COFFIN STILL TIED UP.



COFFIN OPENED, CONTRACTED BURIAL WITH HEADREST.

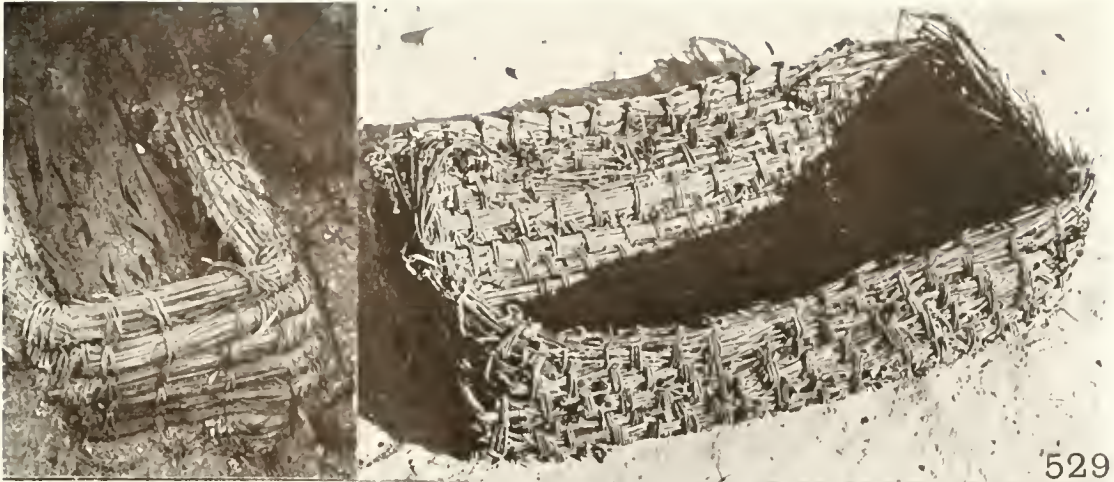

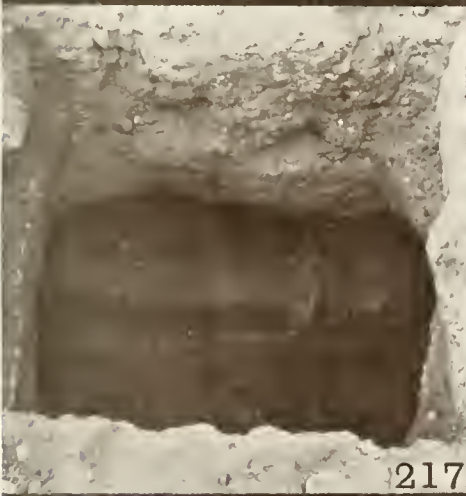

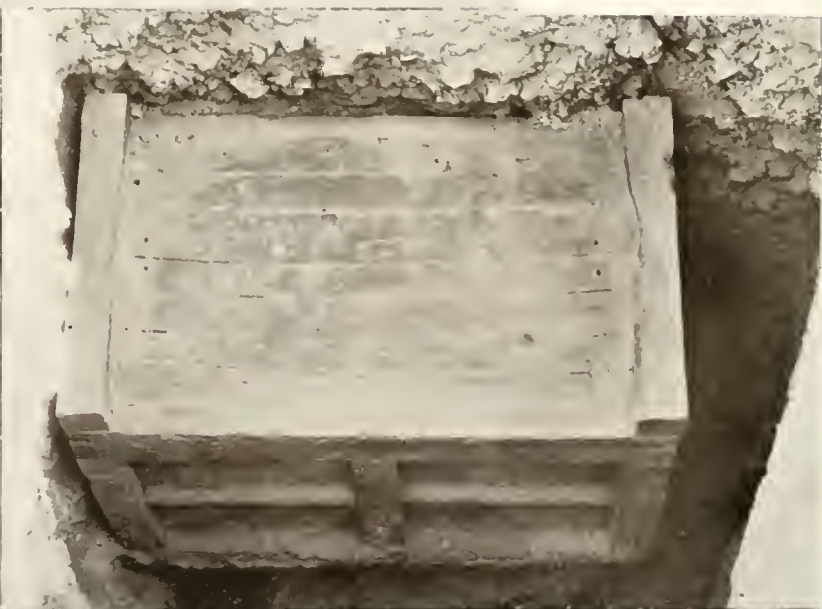

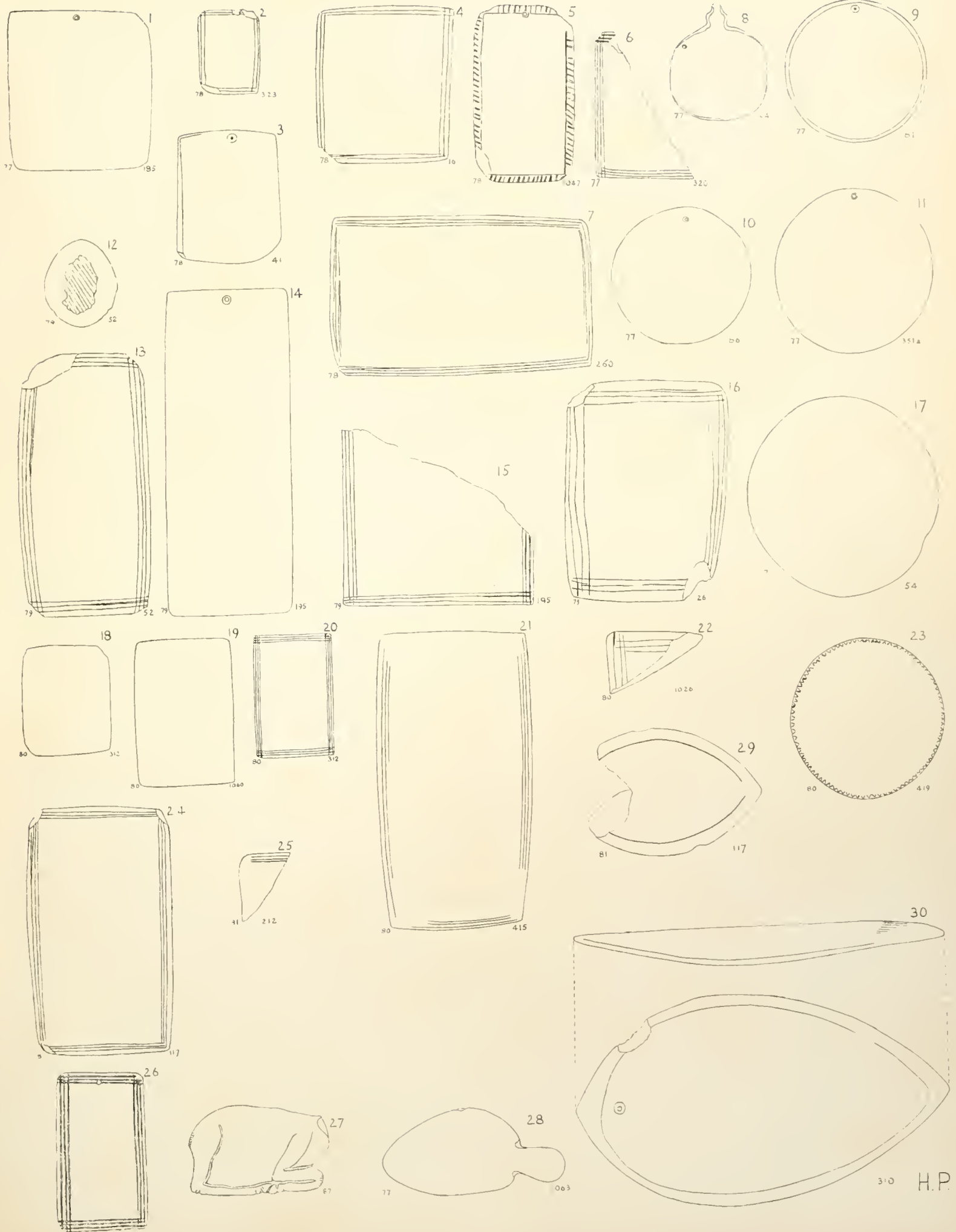

N.M.

310 H.P.

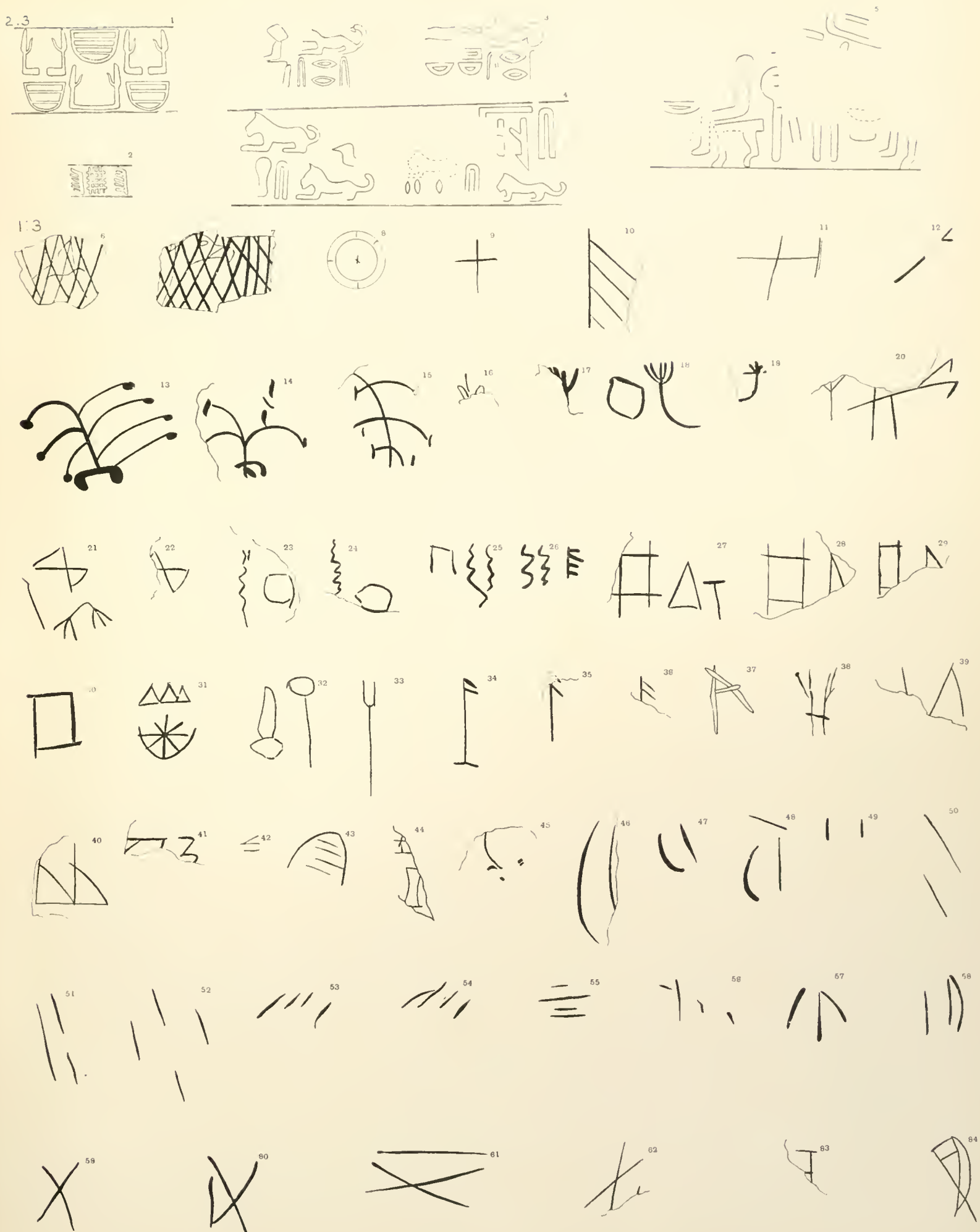

65

66

67



145

ON BACK OF JAR



68



315



261



414



415



300

70

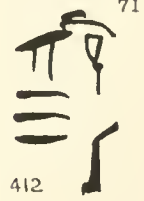

412

F.P.

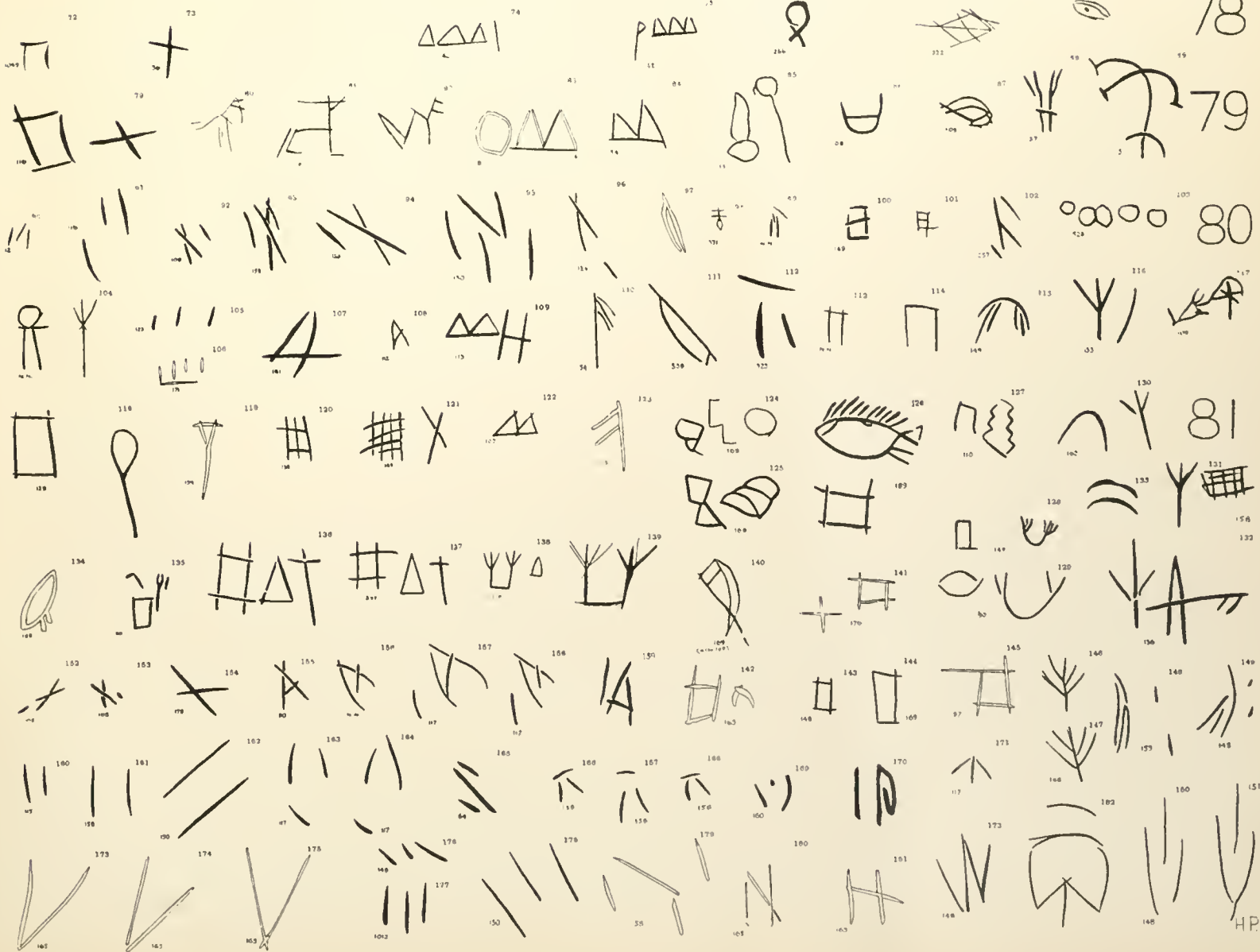

78

79

80

81

H.P.

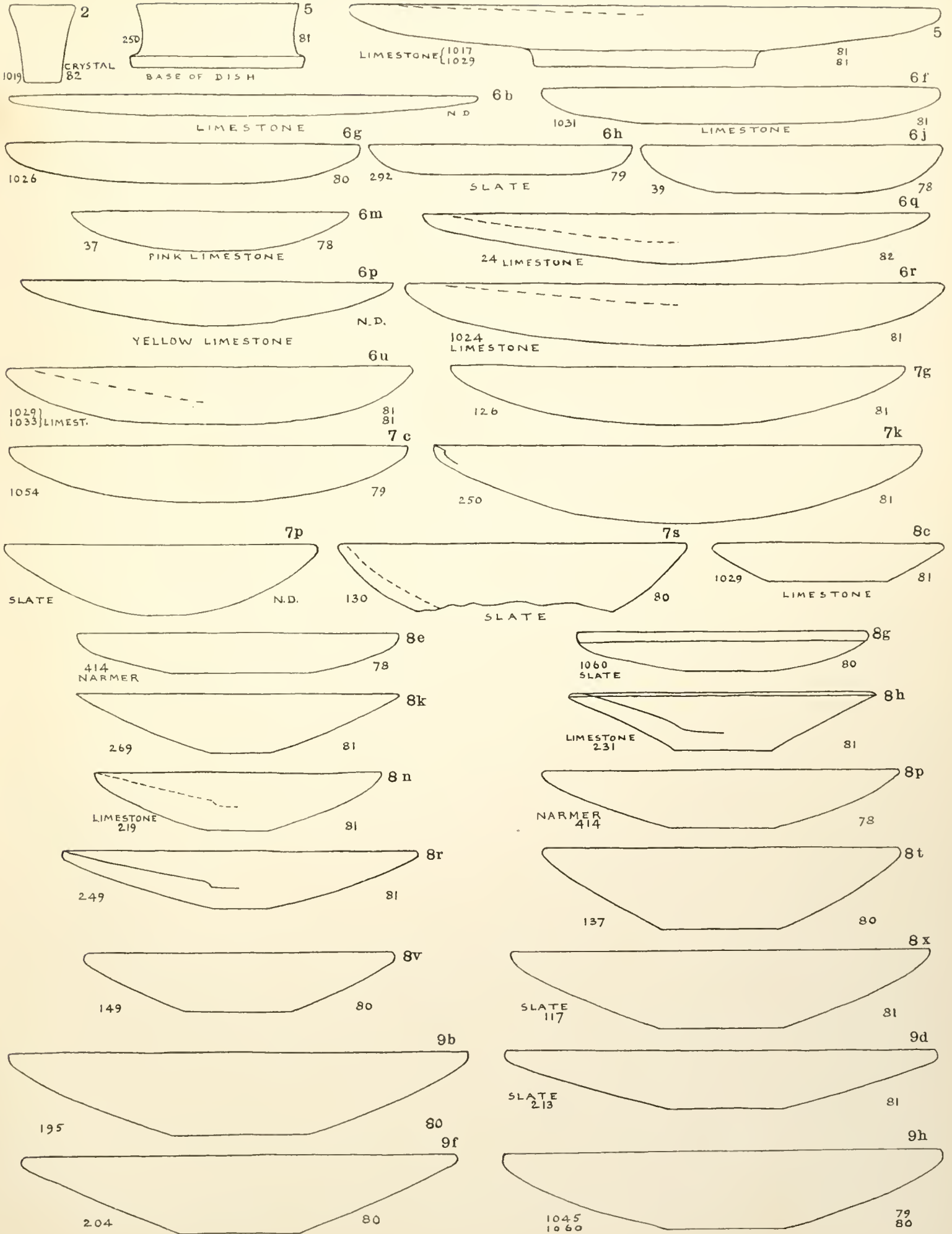

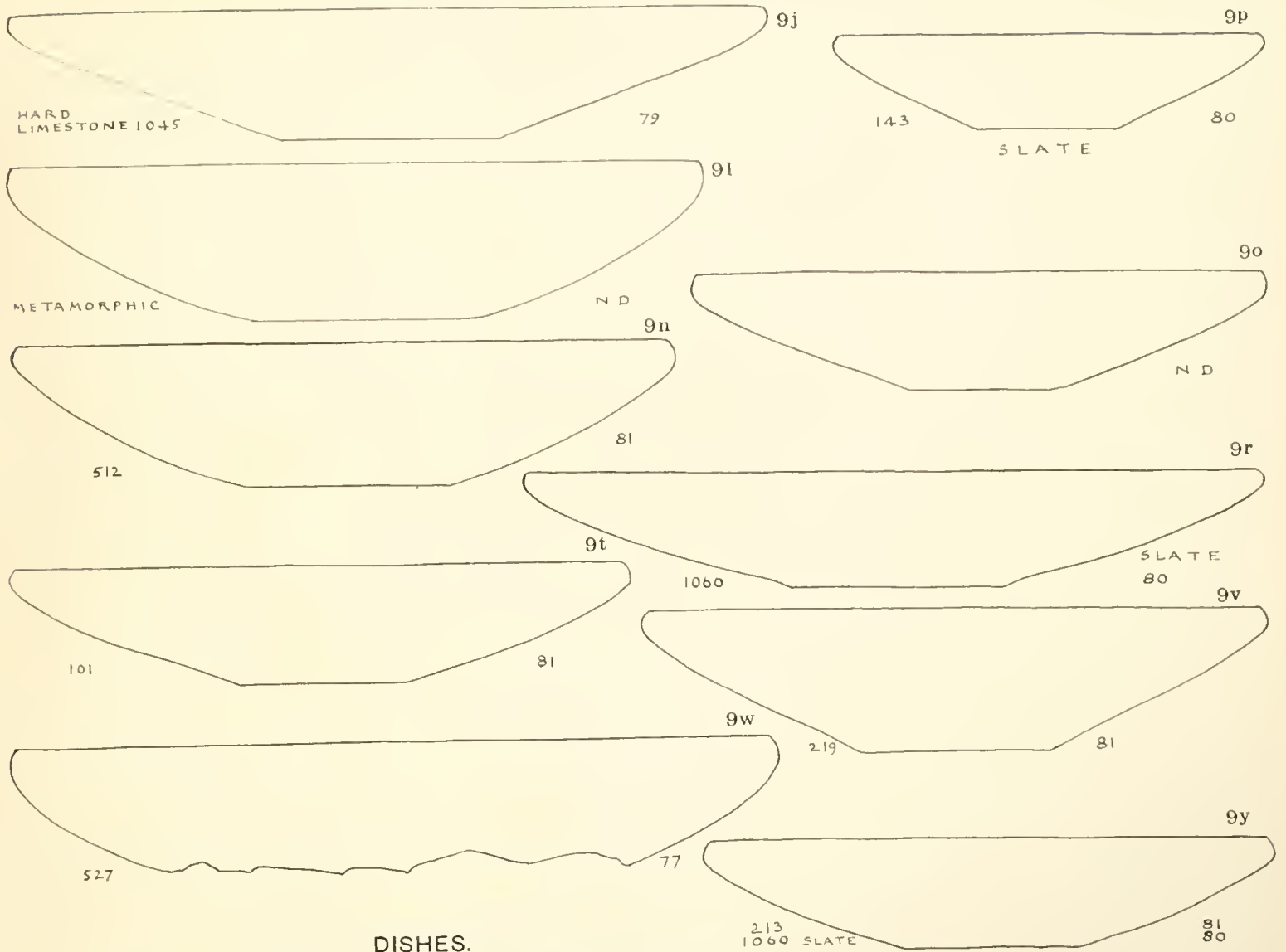

DISHES.

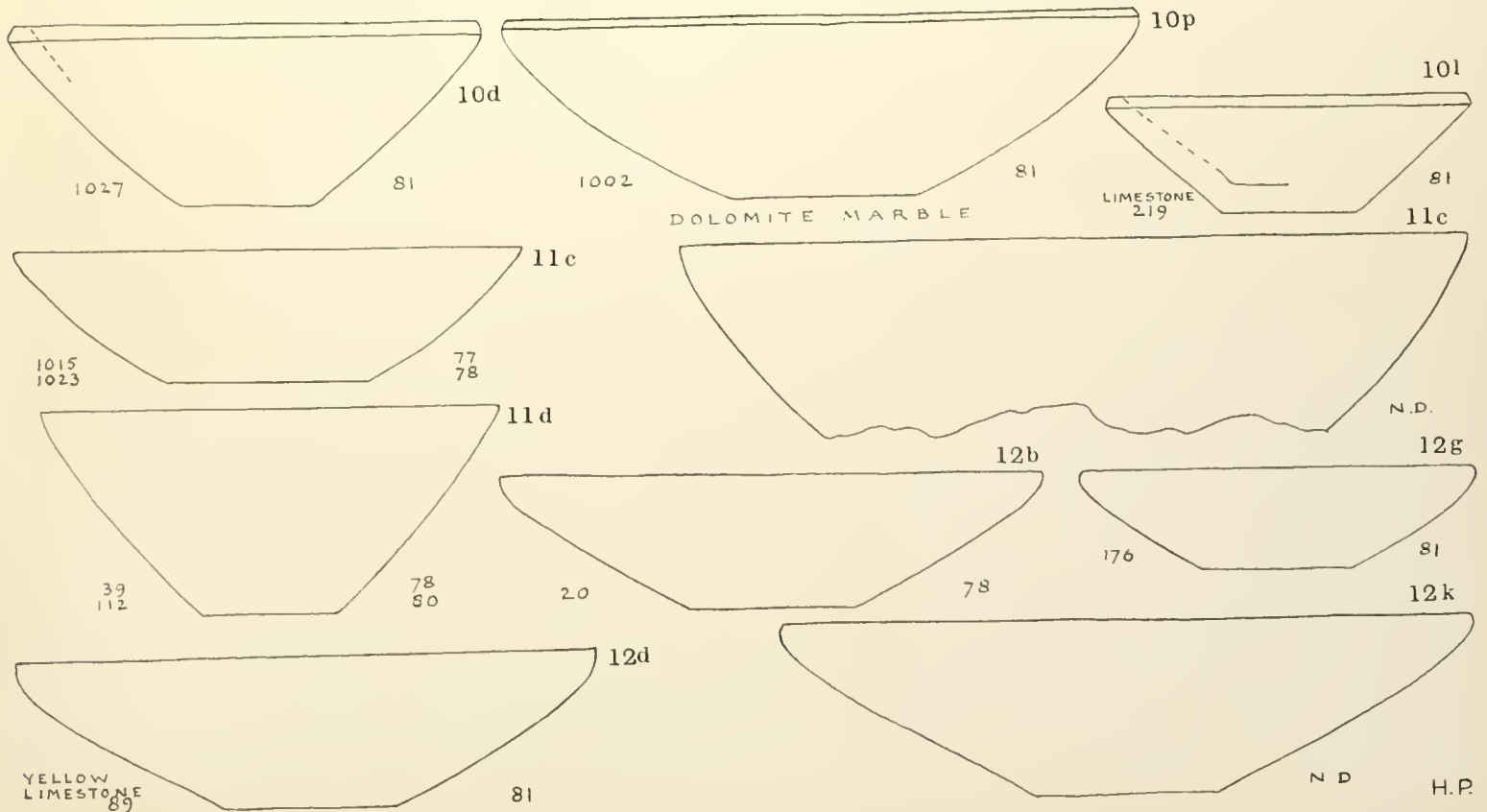



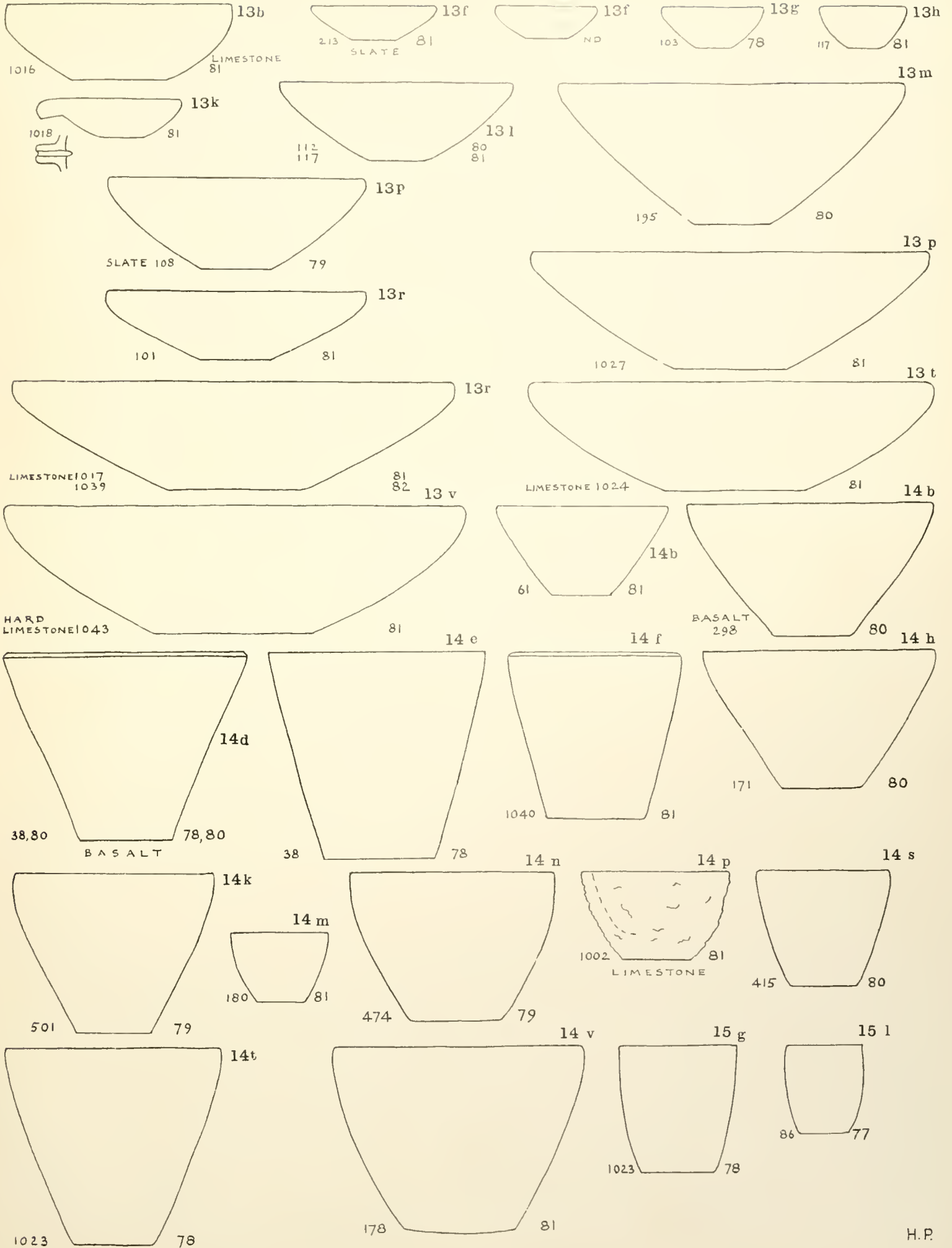

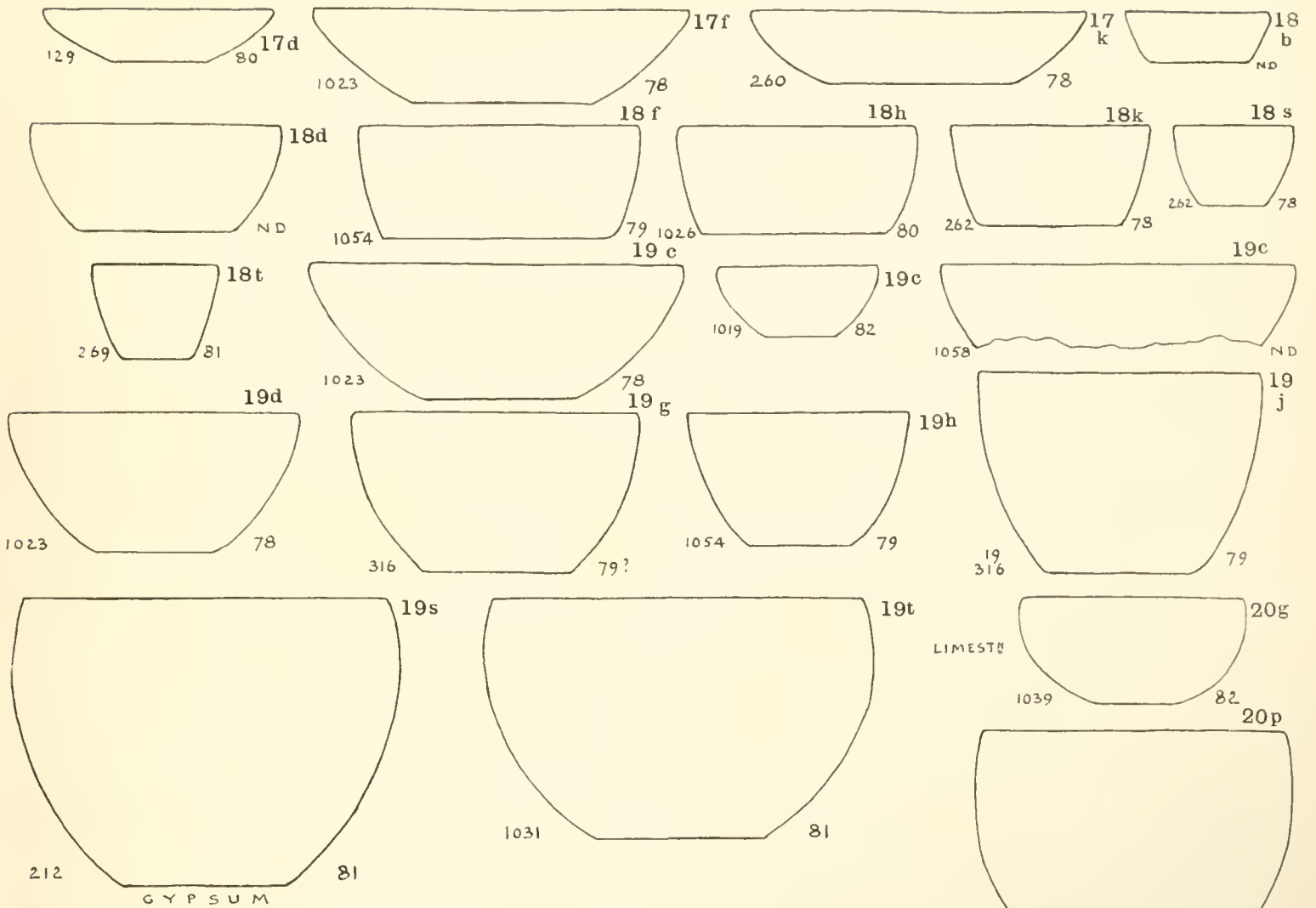

BOWLS (TURNING IN).

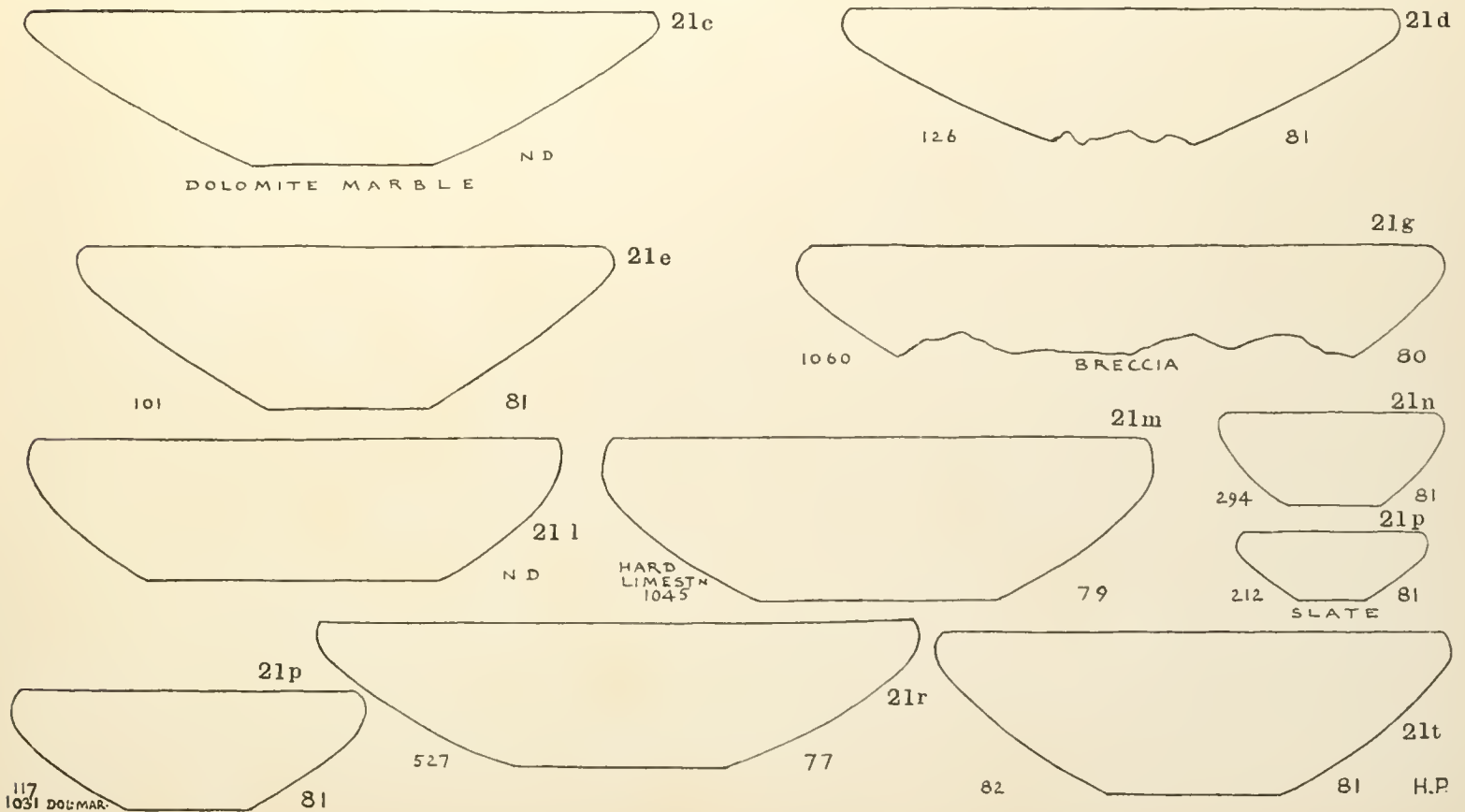

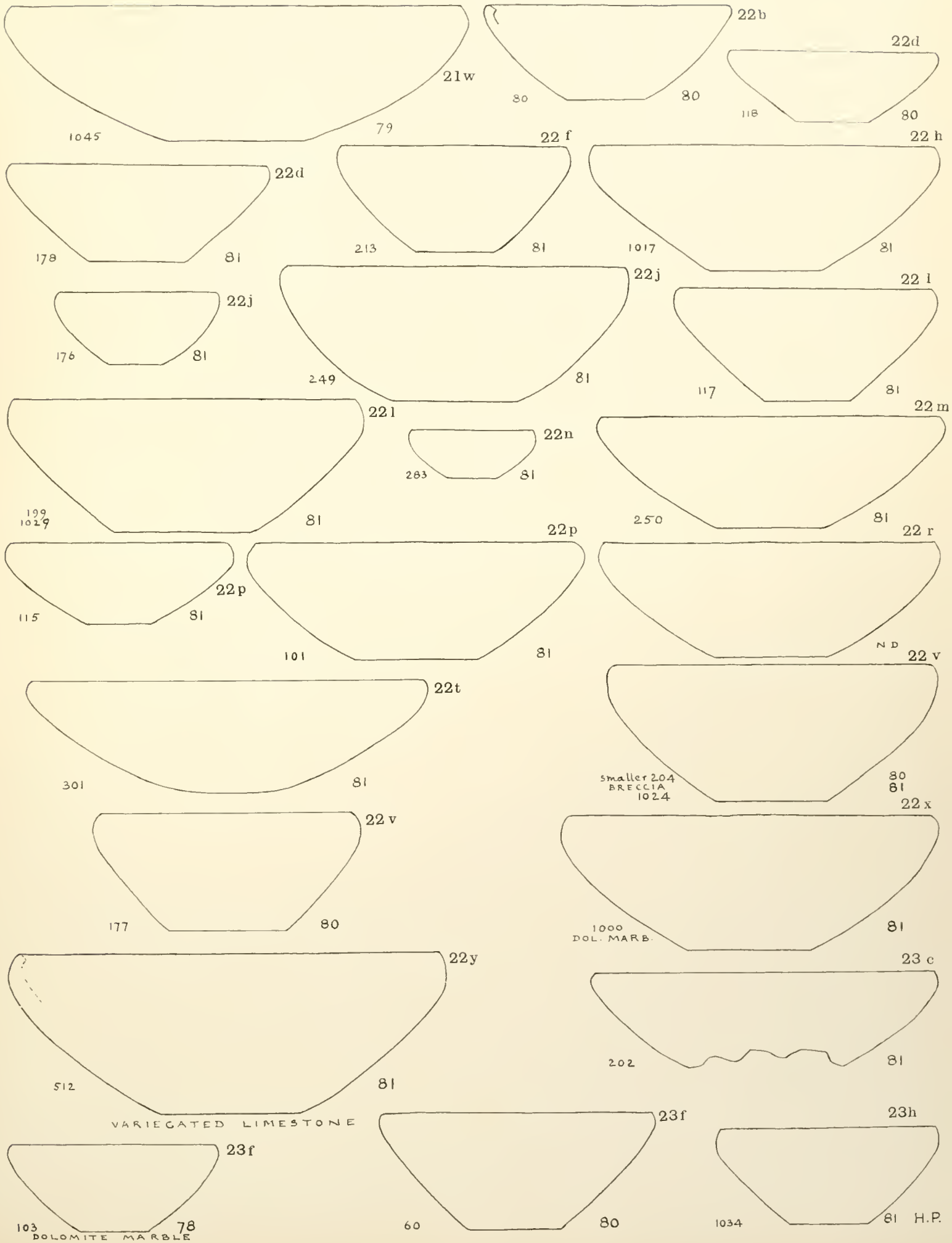

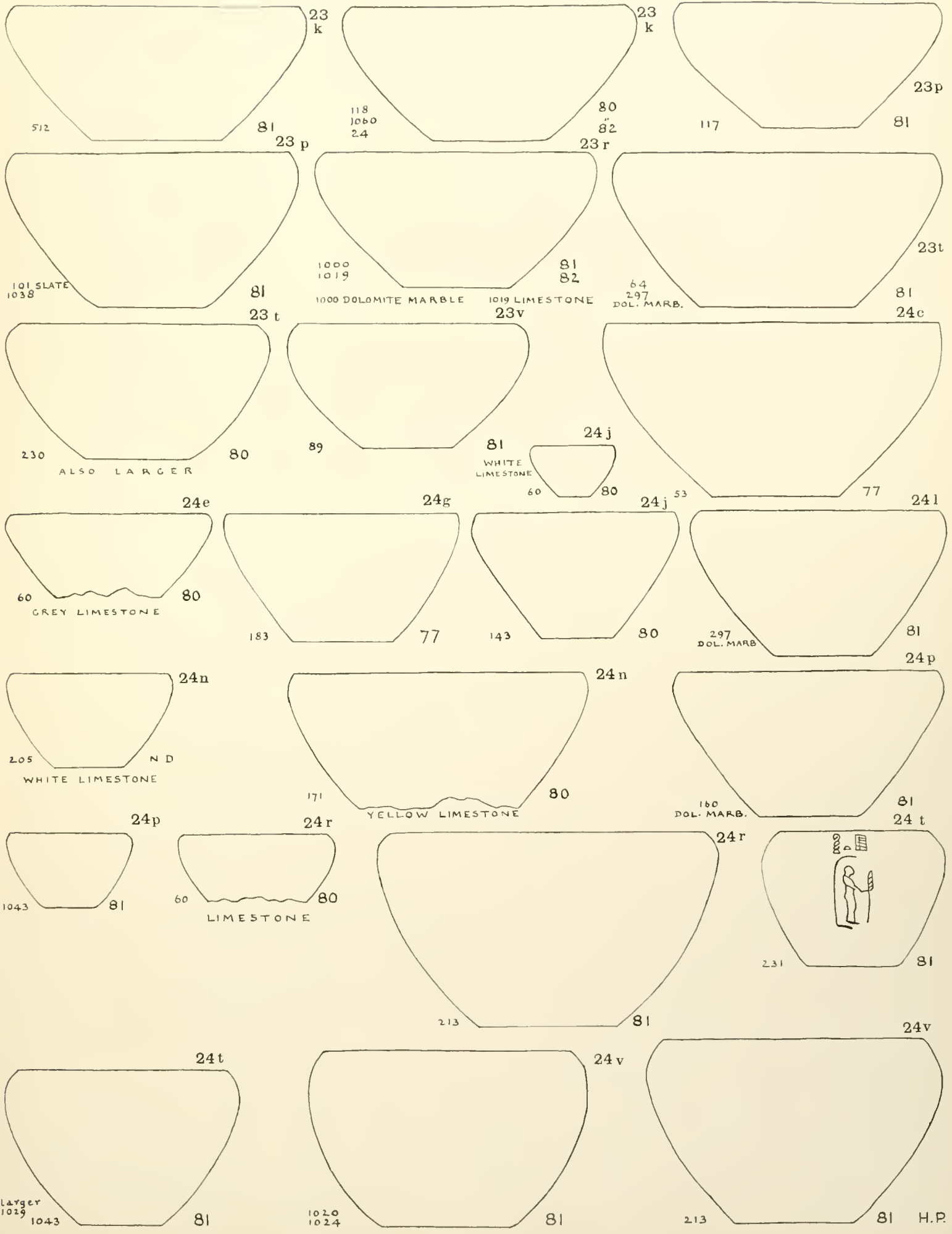

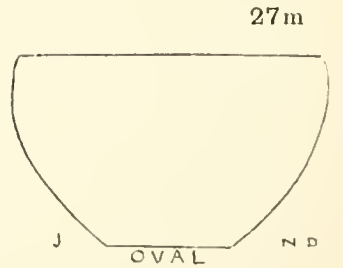
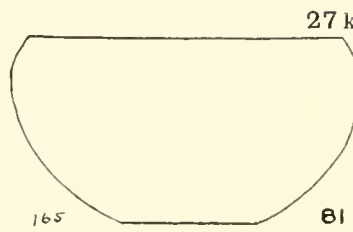
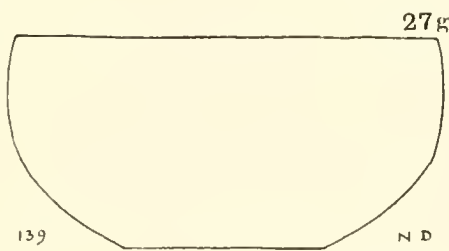
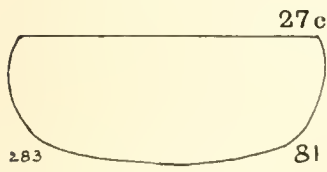
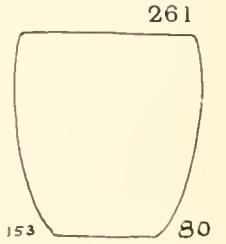
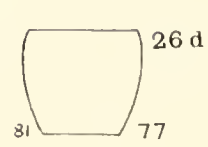
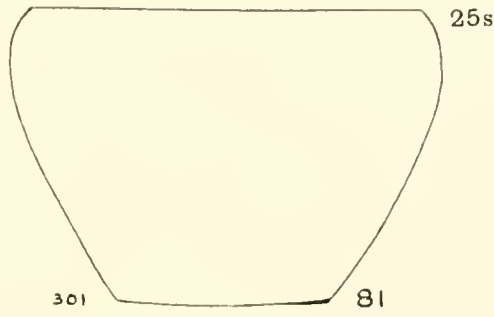
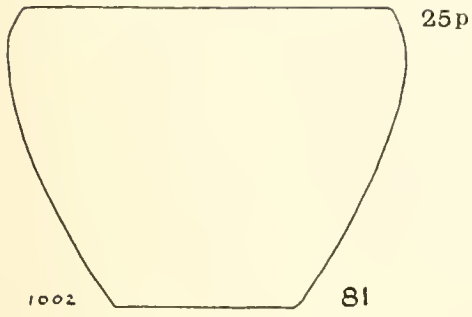
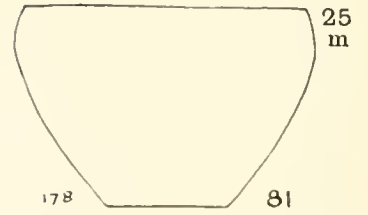
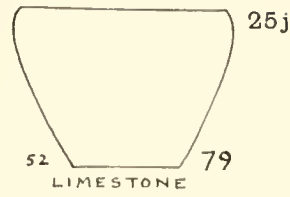
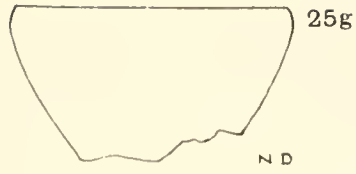
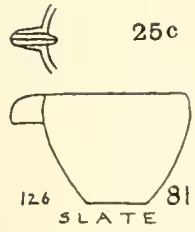

FLEXED DISHES

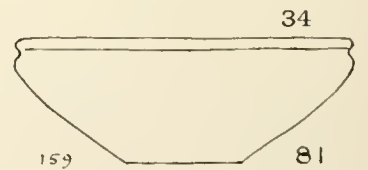
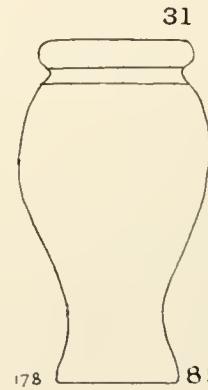
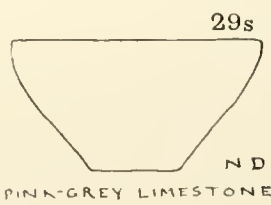
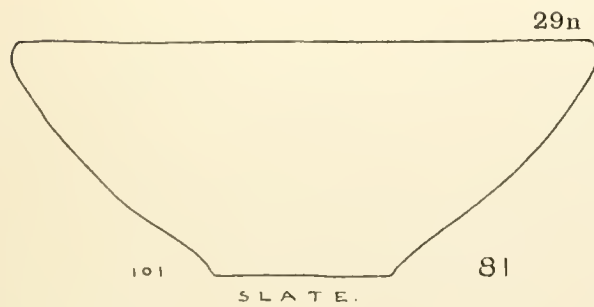
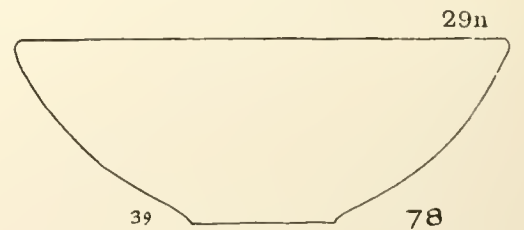
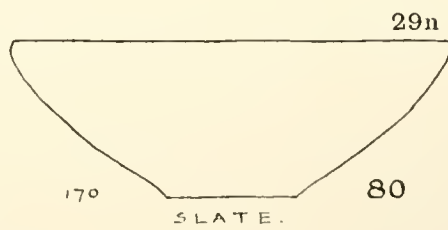
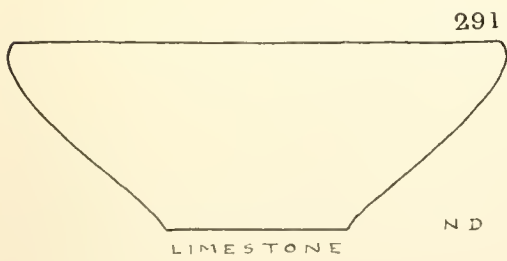
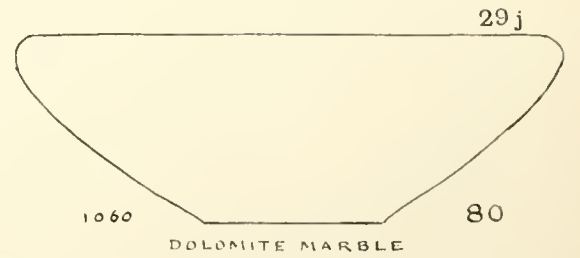
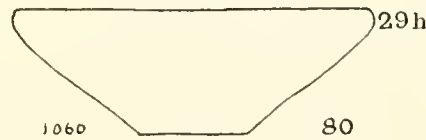
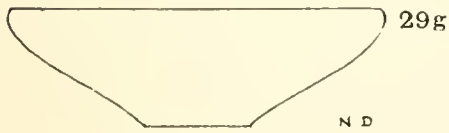

BRIM BOWLS,

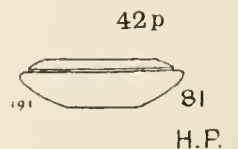
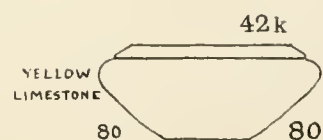
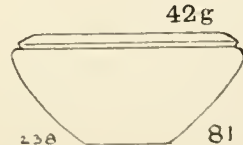
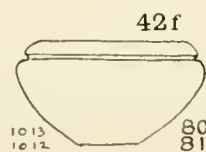
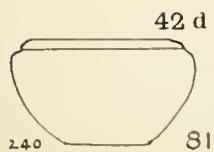

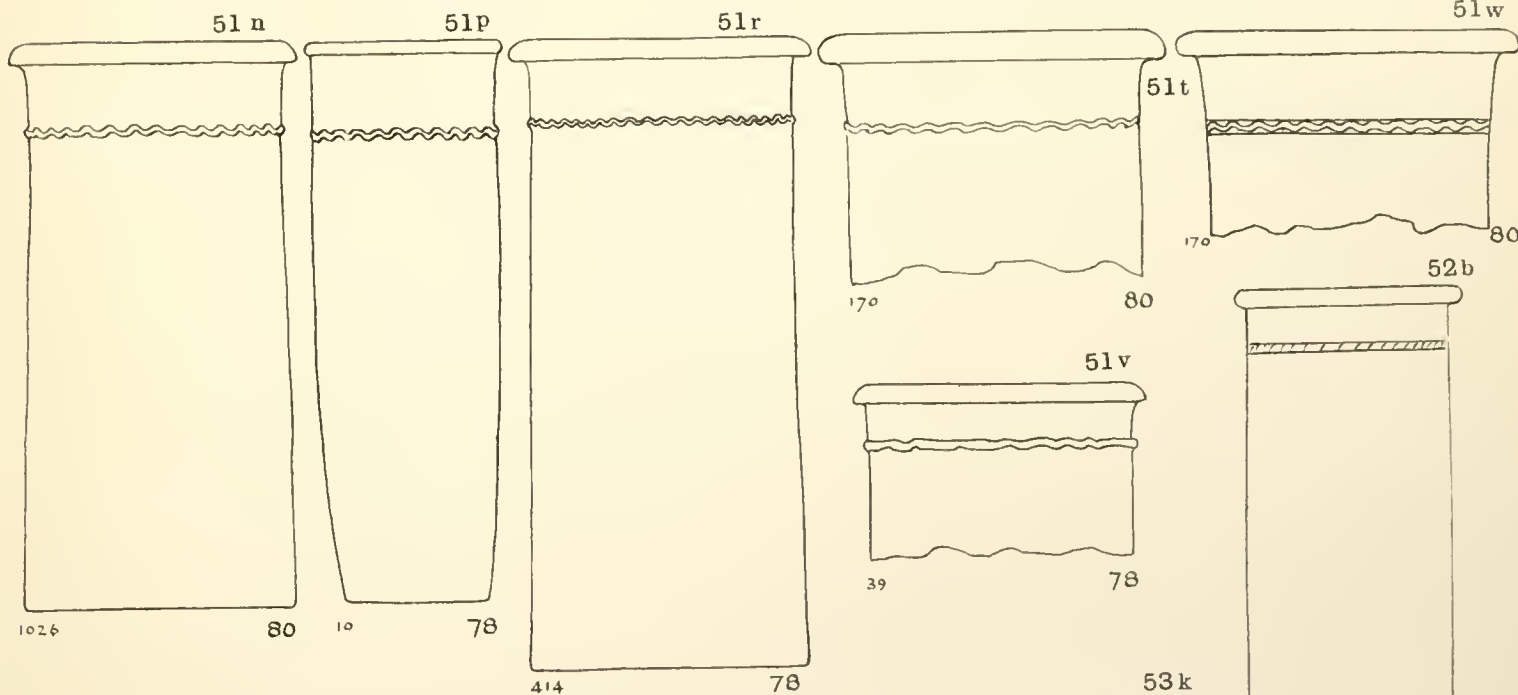
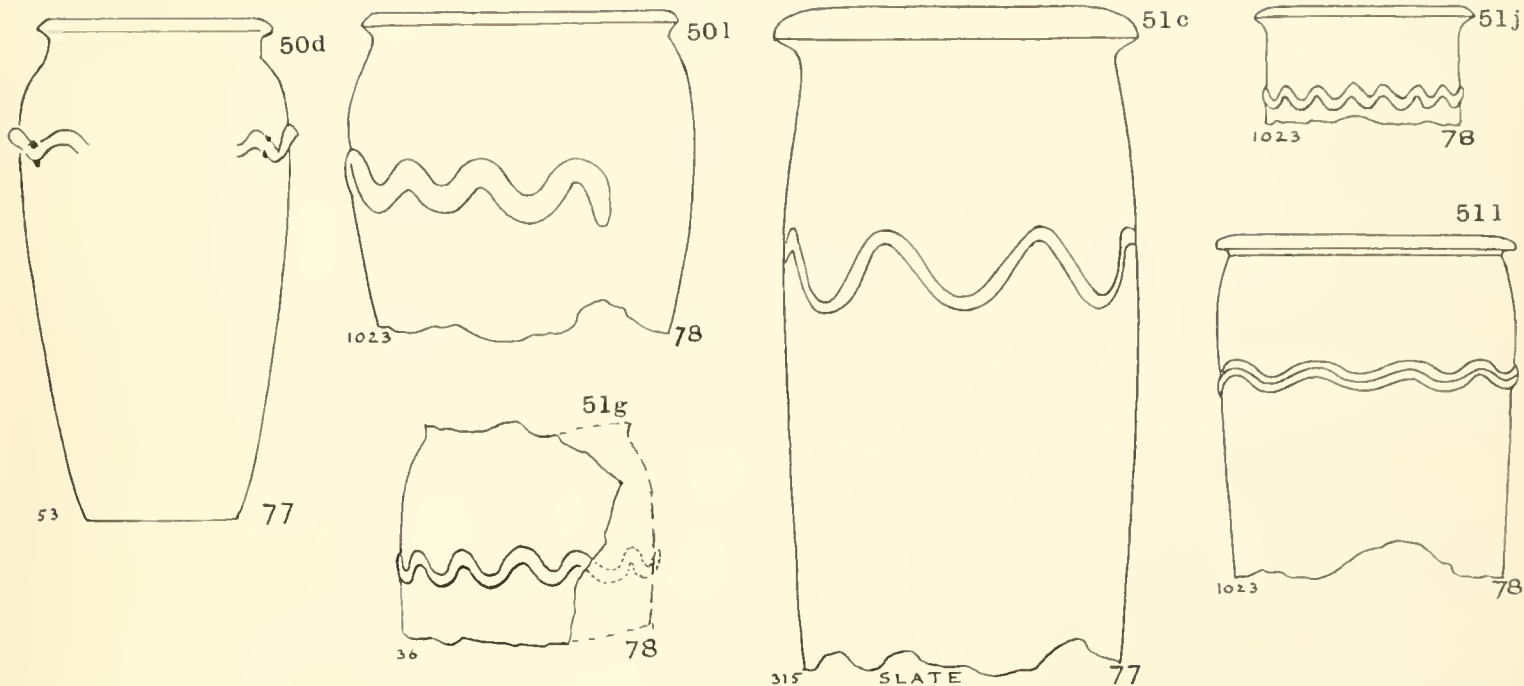

CORDED CYLINDERS.

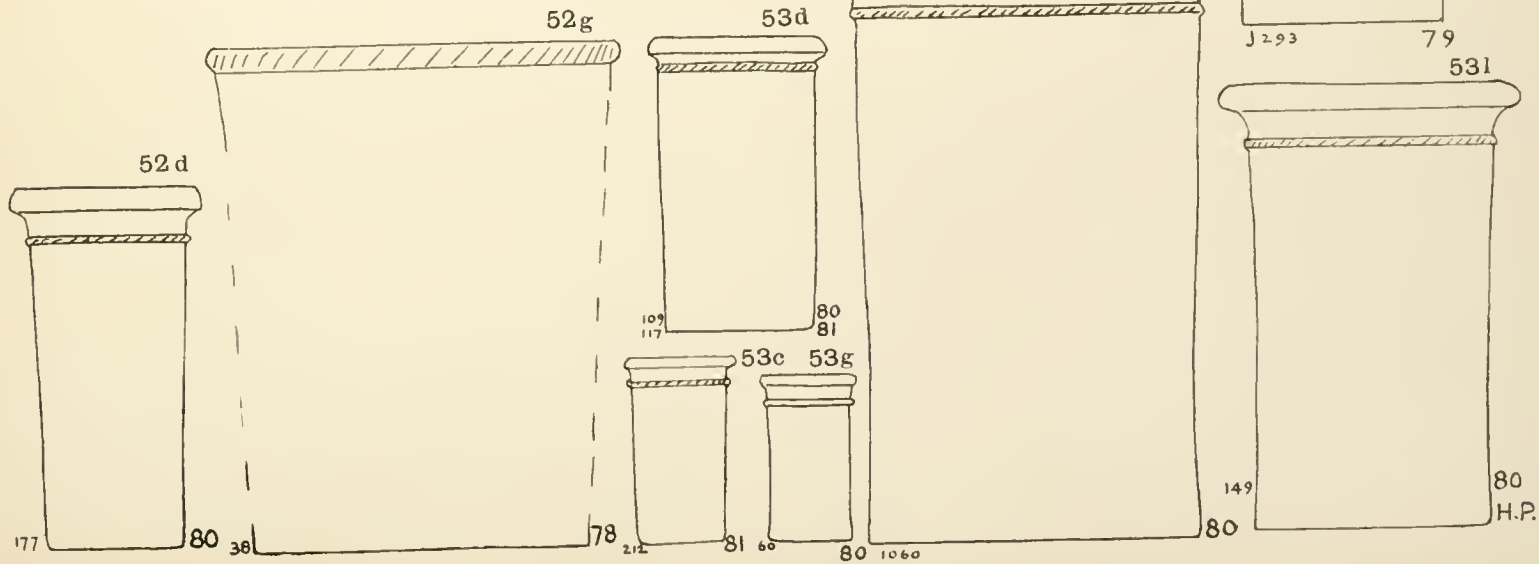

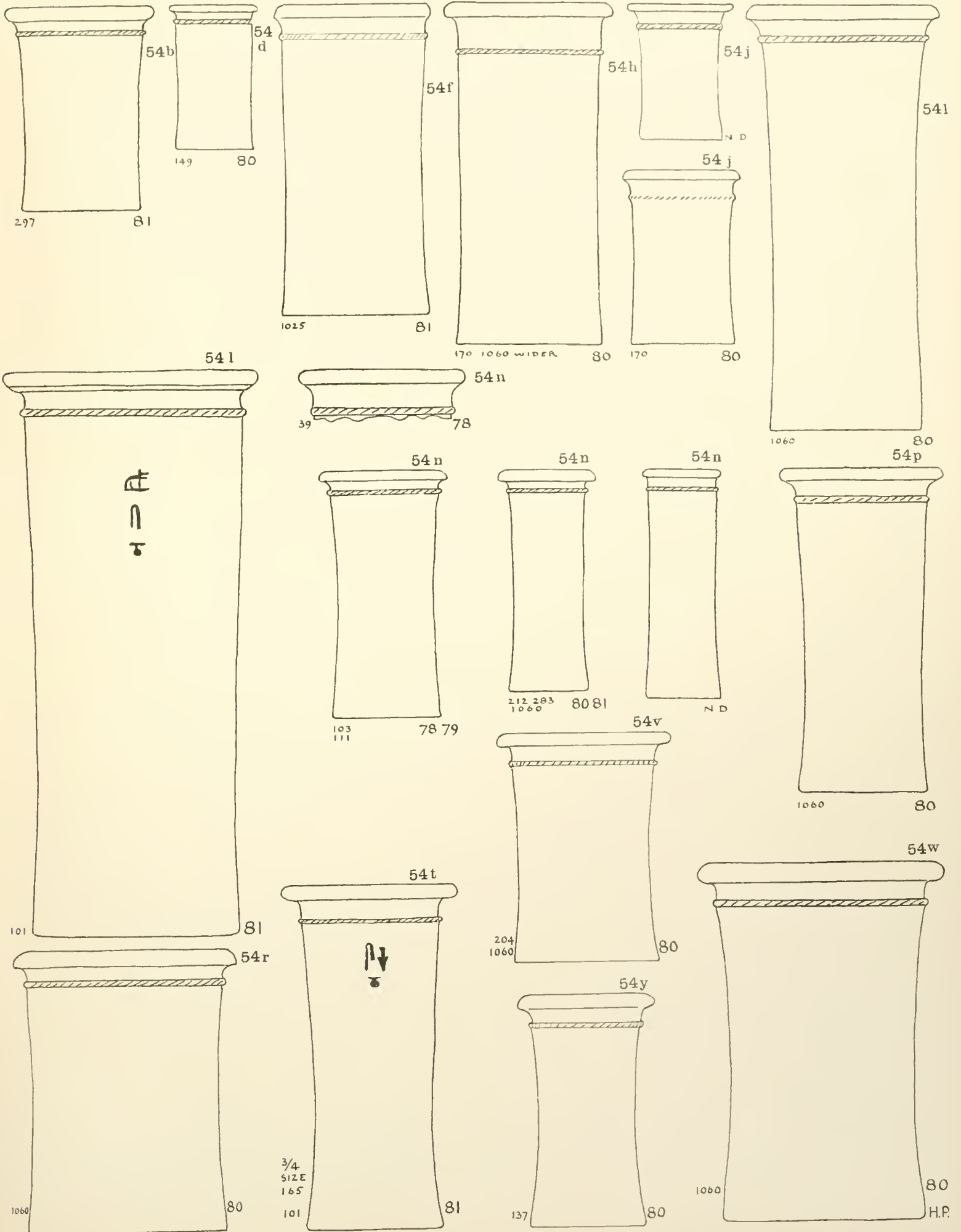

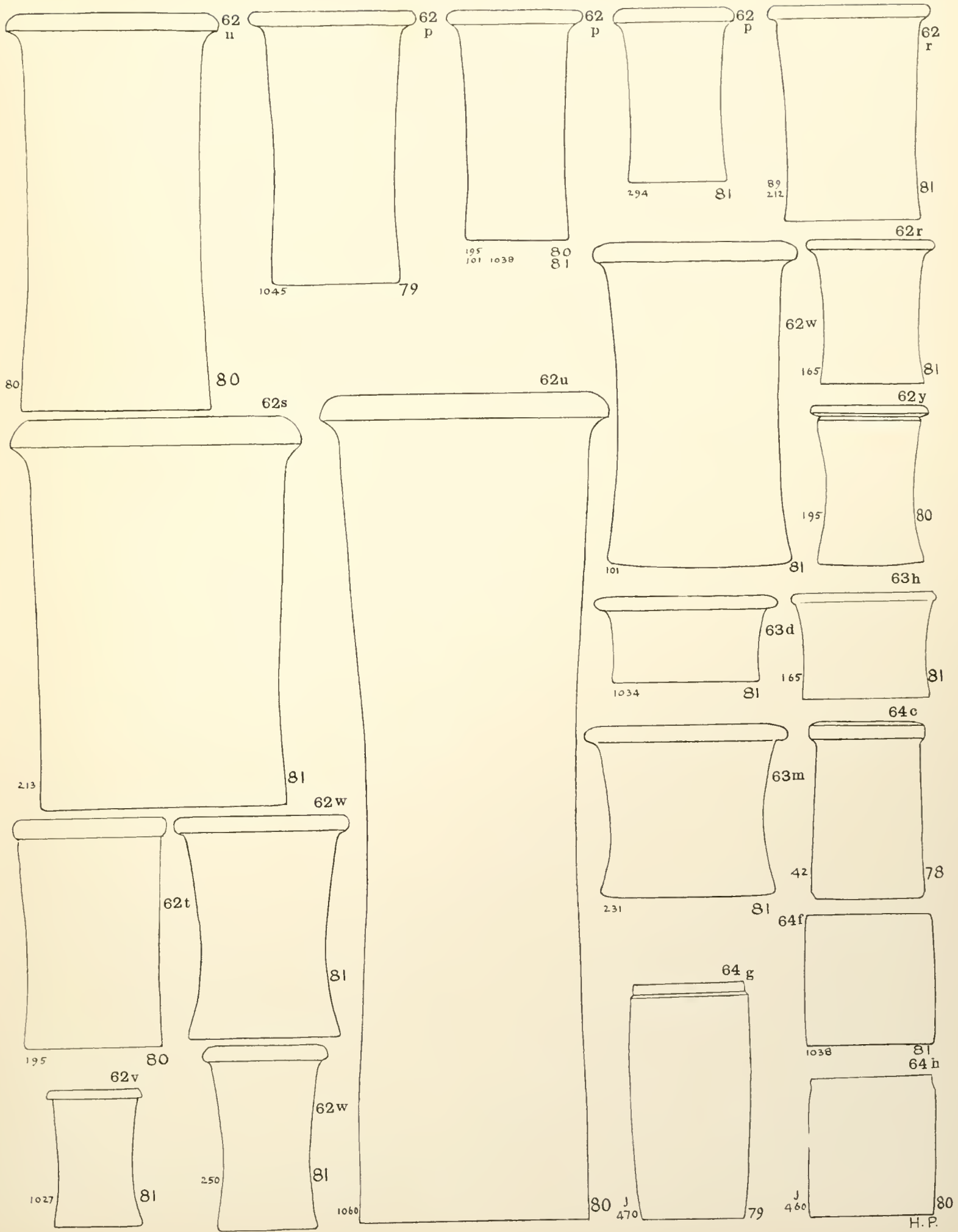

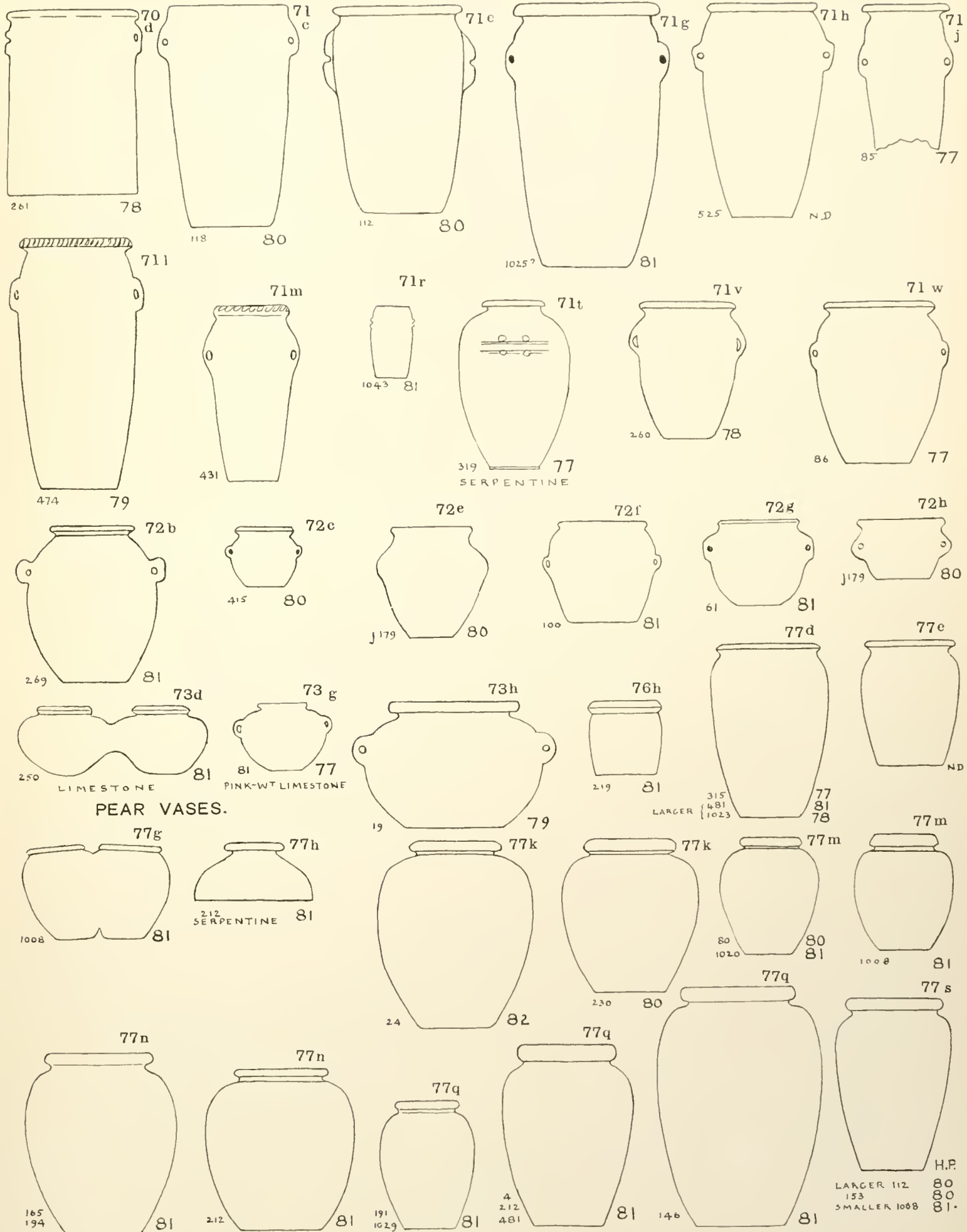

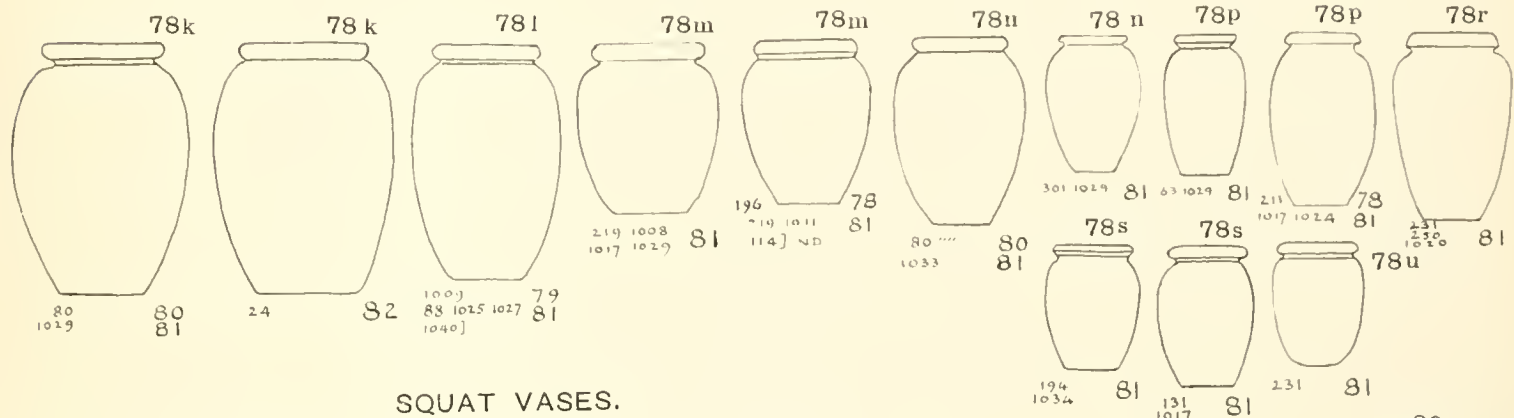
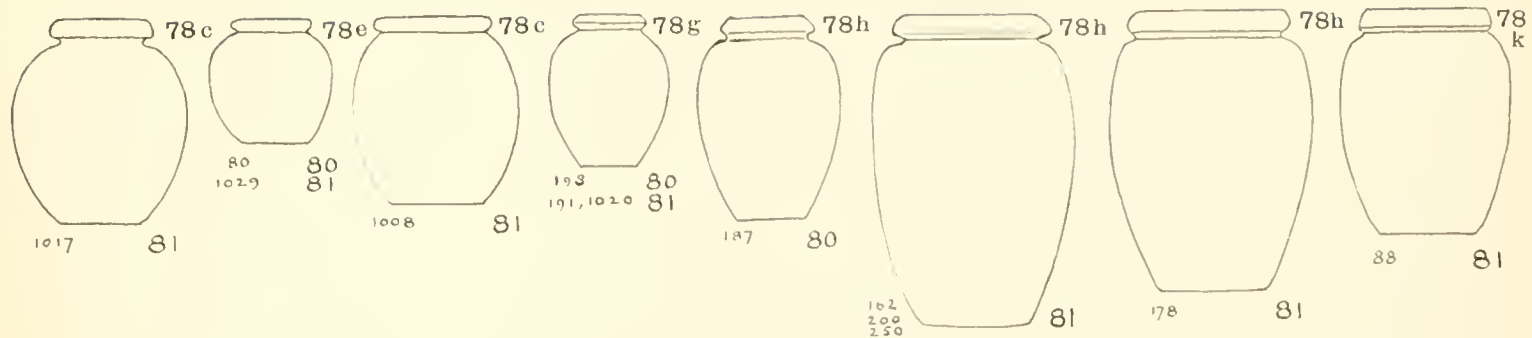

SQUAT VASES.

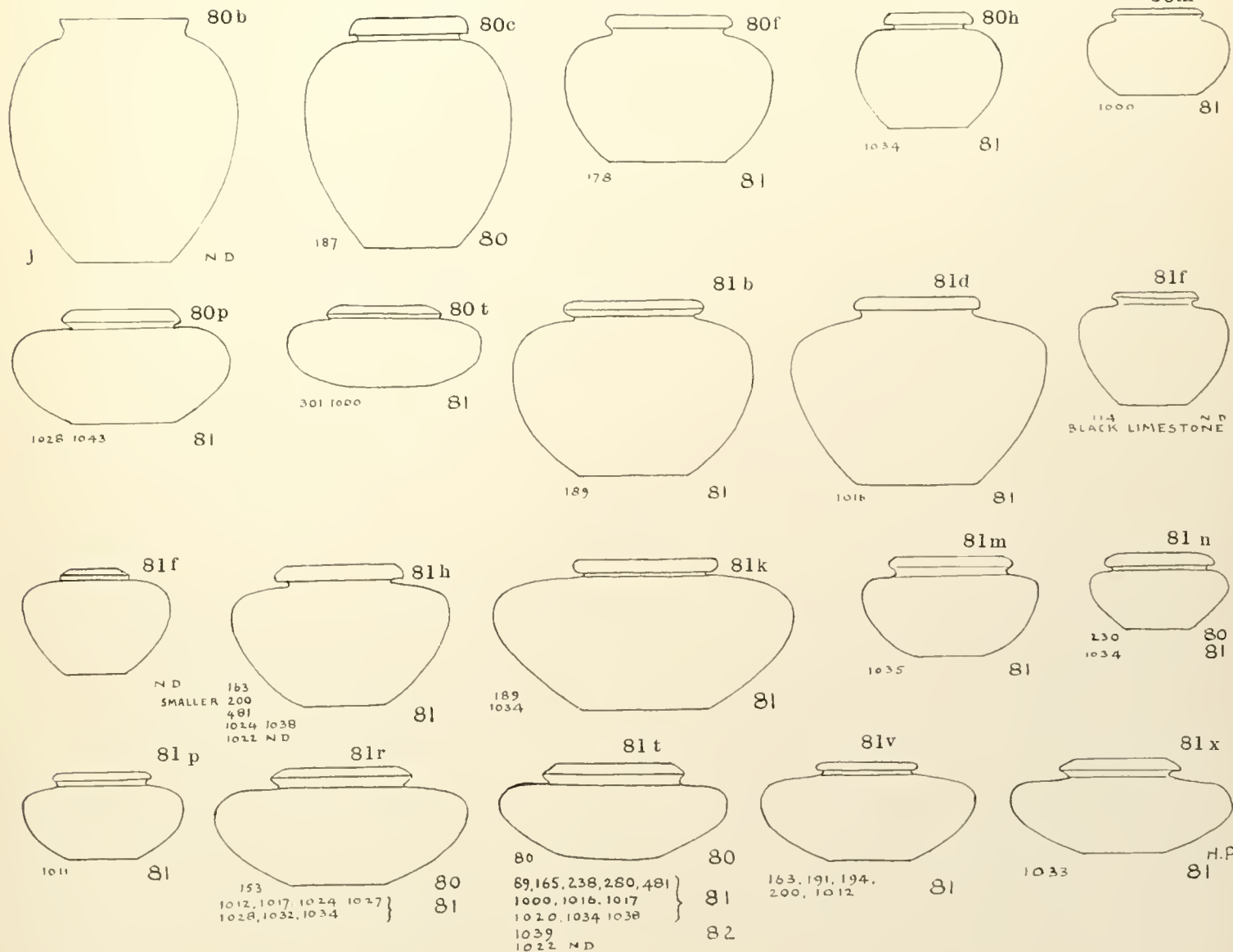

	77 78 79 80 81 82	12g		21m		29j		56d		72c	J
2		12k	○	21n		29l	○	56k		72f	
5	IV	13b	J	21p		29n		56n		72g	
6b	○	13f		21r		29s	○	60b		72h	J
6f		13g		21t		3i		60f		73d	
6g		13h		21w		34		61c		73g	
6h		13k		22b		42d		61d		73h	
6j		13l		22d		42f		61h		76h	
6m		13m		22f		42g		61j	JJ	77d	
6p	○	13p	J	22h		42j		61k		77e	○
6q		13r		22j		42k		61l		77g	
6r		13t		22l		42p		61n	○	77h	
6u		13v		22m		50d		61p		77k	
7c		14b	J	22n		50l		62b		77m	
7g		14d		22p		51c		62c		77n	
7k		14e		22r	○	51g		62e		77q	VI
7p	○	14f		22t		51j		62g	V	77s	
7s		14h		22v		51l		62h	VIII	78c	
8c		14k		22x		51n		62k		78e	
8e		14m		22y		51p		62l		78g	
8g		14n		23c		51r		62n		78h	IV
8h		14p		23f		51t		62p		78k	
8k		14s		23h		51v		62r		78l	
8n		14t		23k		51w		62s		78m	VI
8p		14v		23p		52b		62t		78n	IV
8r		15g		23r		52d		62u		78p	IV
8t		15j		23t		52g		62v		78r	
8v		15l		23v		53c		62w		78s	
8x		17d		24c		53d		62y		78u	
9b		17f		24e		53g		63d		80b	○
9d		17k		24g		53k		63h		80c	
9f		18b	○	24j		53l		63m		80f	
9h		18d	○	24l	J	54b		64c		80h	
9j		18f		24n	○	54d		64f		80m	
9l	○	18h		24p		54f	?	64g	?	80p	
9n		18k		24r		54h		64h		80t	
9o	○	18s		24t		54j		70d		81b	
9p		18t		24v		54l		71c		81d	
9r		19c	JJ	25c	J	54n		71e		81f	○
9t		19d		25g	○	54p		71g		81h	V
9v		19g	?	25j		54r		71h	○	81k	
9w		19h		25m		54t		71j		81m	
9y		19j		25p		54v		71l		81n	
10d		19s		25s		54w		71m	JJ	81p	
10l		19t		26d		54y		71r		81r	VII
10p		20g		26l		55a		71t		81t	XV IV
11c		20p		27c		55c		71v		81v	V
11d		21c	○	27g	J	55f		71w		81x	
12b		21d		27k		55k		72b			
12d		21e		27m	○	55n		72c			
		21g		29g	○	55s	○				
		21l	○	29h							

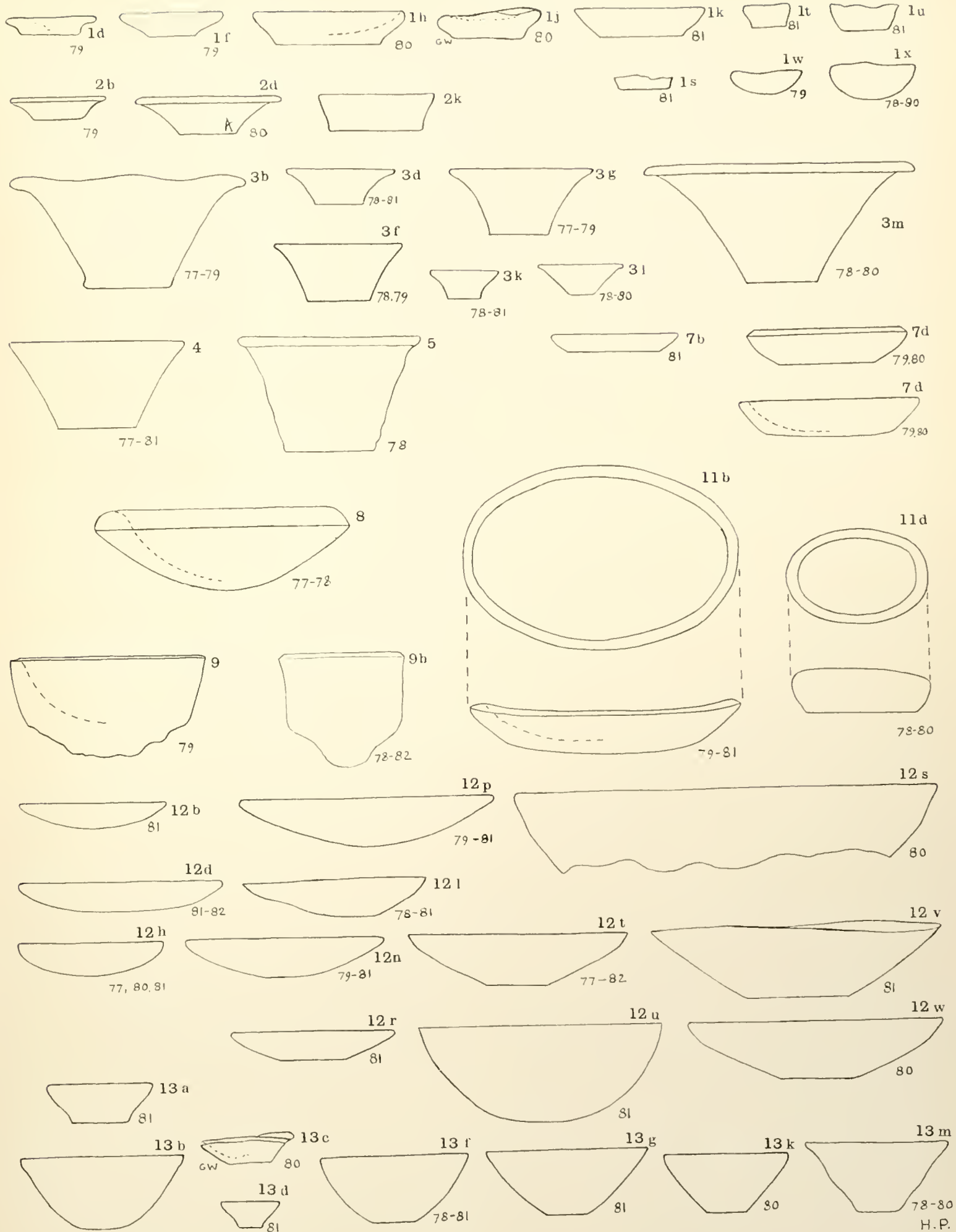

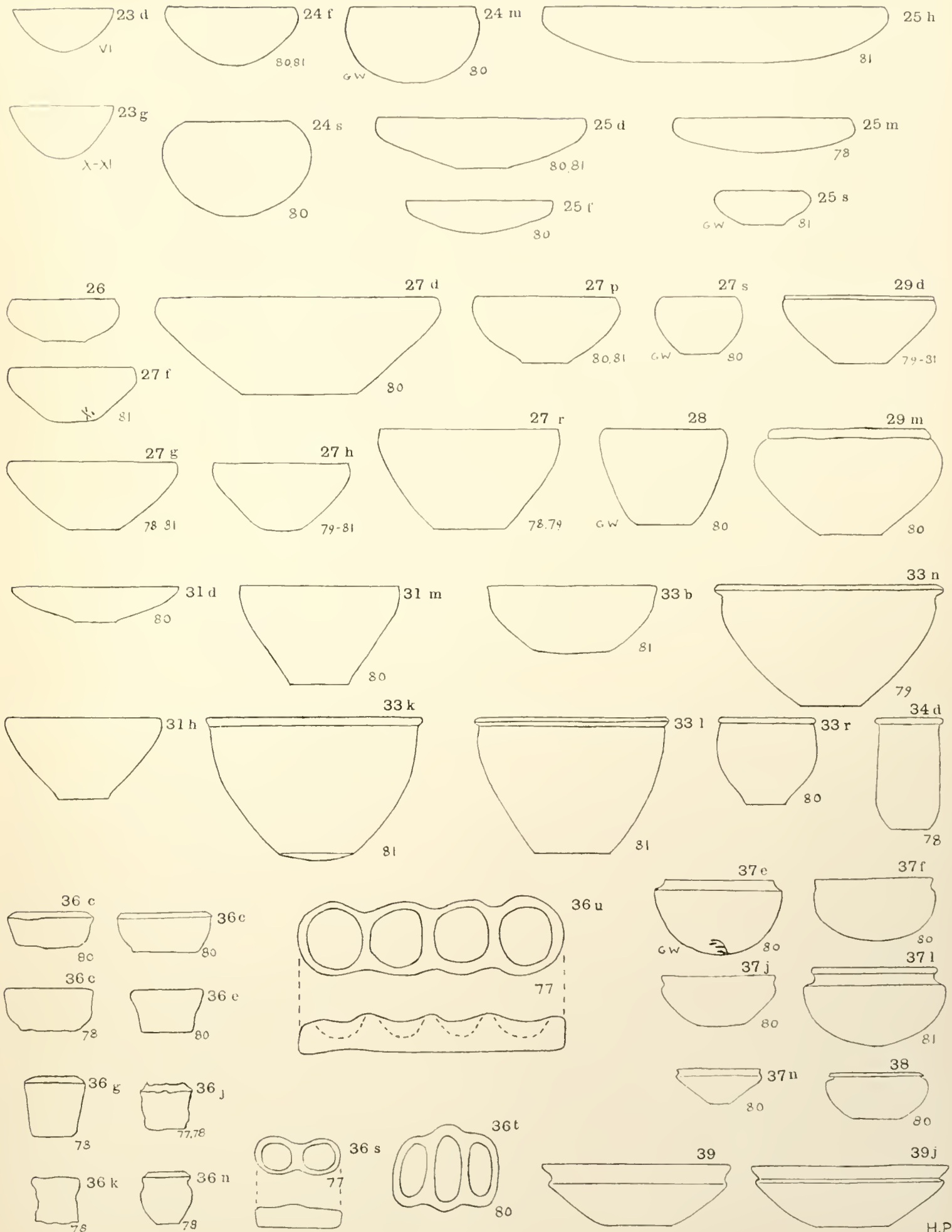

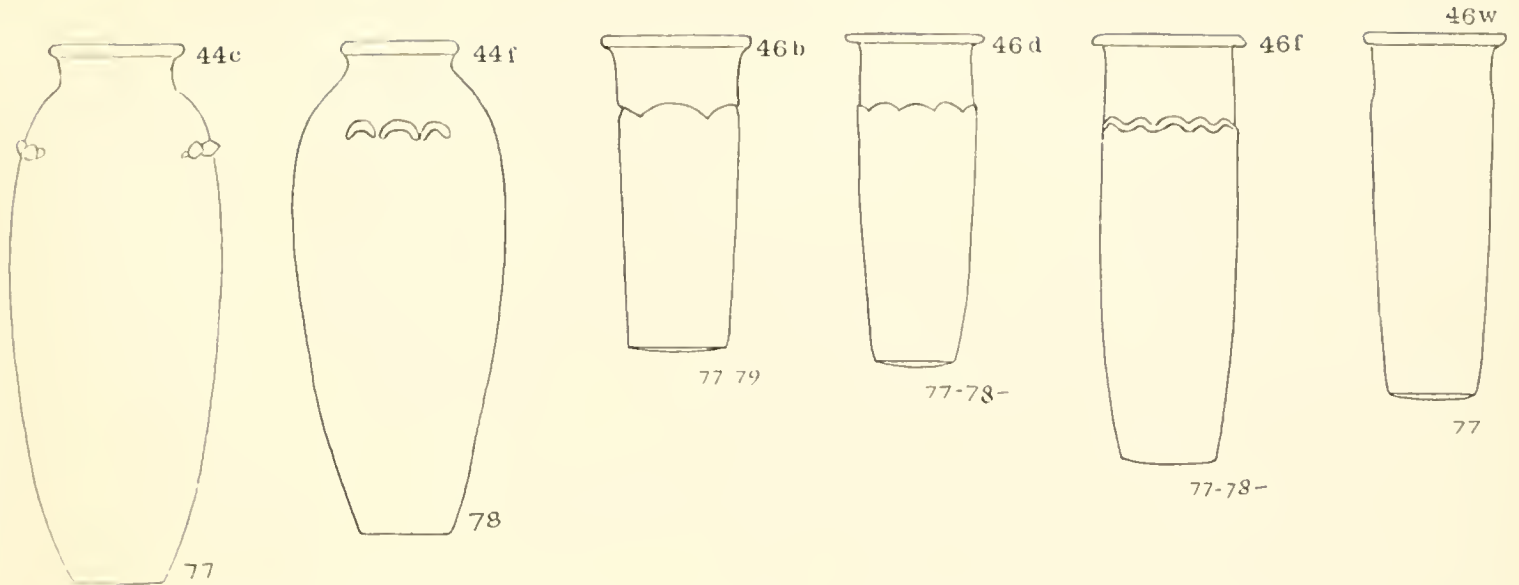

TYPE PATTERNS ON CYLINDER JARS.

46b		Bold projecting ridges. ^{77,78-}	46m		Wiped low above ridge pushed up. ⁷⁷⁻
46d		Sharp ridge pushed up. ^{77,78-}	46p		Wiped low above, ridge smudged up. ^{77,78}
46f		Pushed up, flattened. ^{77,78-}	46r		Faint irregular hollows. ⁷⁷
46h		Squeezed up by thumb. ^{77,78-}	46t		Faint ridge dabbed by fingers. ⁷⁷
46k		Squeezed in by finger. ^{77,78-}	46w		Faint lumps. ⁷⁷
47b		Jabbed up with a stick. ⁷⁸⁻⁷⁹	47k		Deep groove scored by stick. ⁷⁹
47d		Jabbed with finger nail. ⁷⁷⁻⁷⁹	47m		Deep groove, lower edge smudged. ⁷⁸⁻⁸⁰
47f		Wiped with stick or finger. ⁷⁸	47p		Wiped low below, ridge pushed up. ^{-77,78-}
47h		Wiped low below, ridge pushed up. ⁷⁷⁻⁷⁹	47s		same. ^{78,79}
48d		{ Wiped low above and below, ridge notched. ⁷⁸	48s		Cord impress. ⁷⁸⁻
48g		{ Ridge notched, deep groove below. ^{78,79}	48t		Cord impress left handed. ⁷⁸⁻
48l		{ Slight groove, upper edge notched. ⁷⁸⁻	49g		Jabbed by a point. ⁷⁸⁻⁸⁰
49d		Groove, upper edged pushed wavy. ^{78,79}	49l		Plain line. ⁷⁸⁻⁸⁰

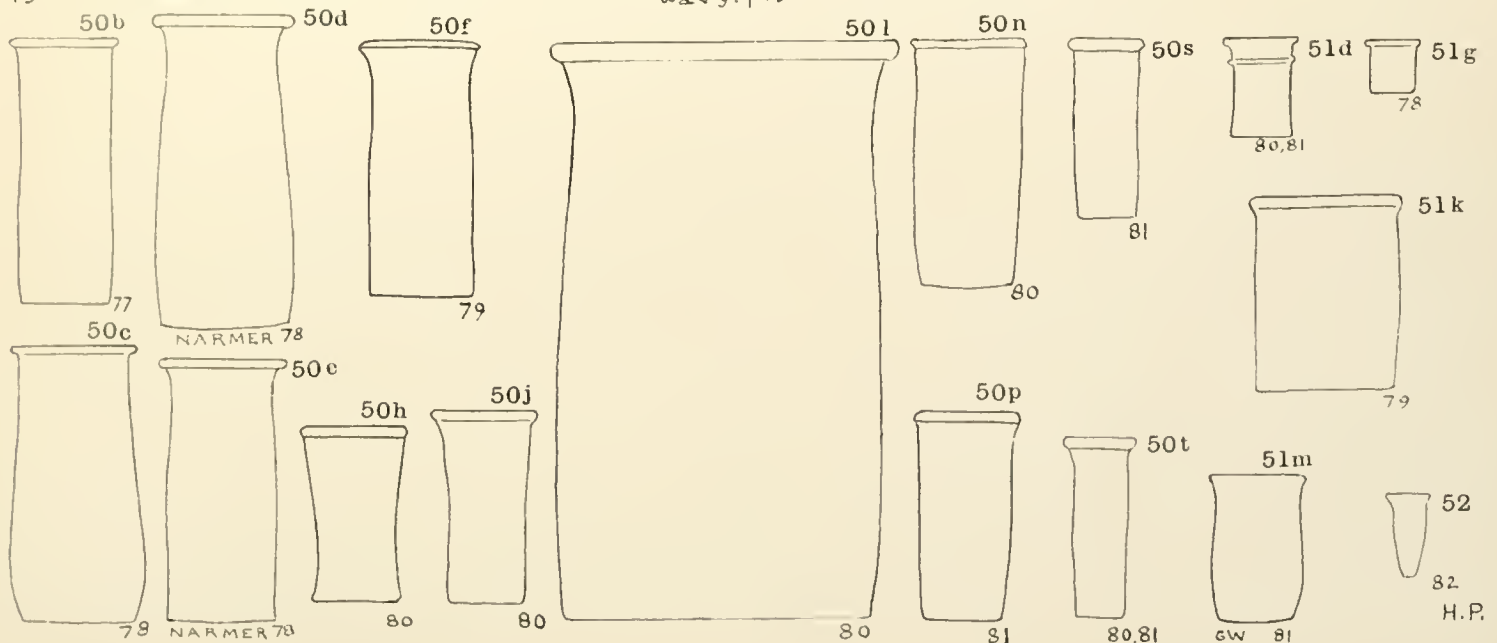

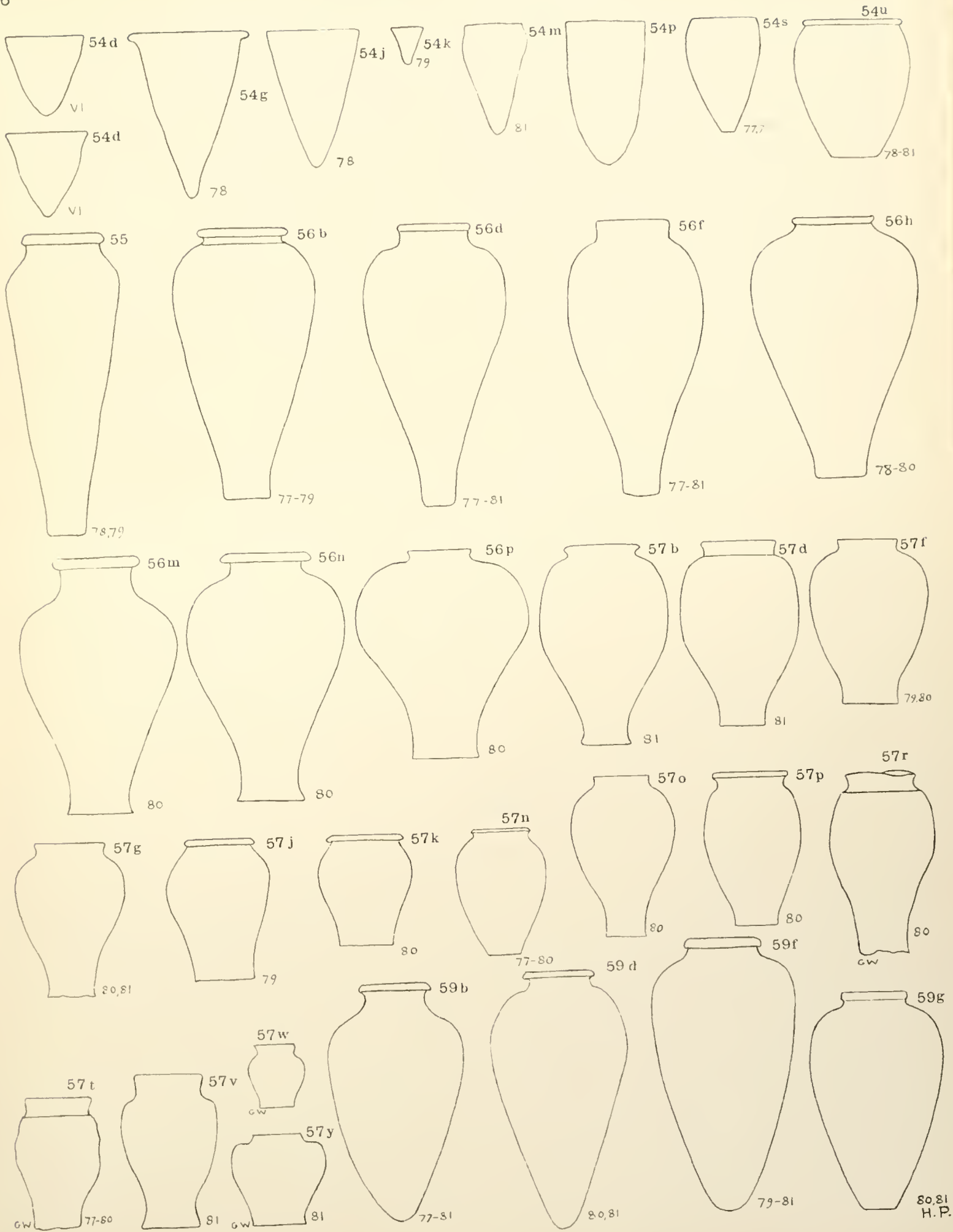

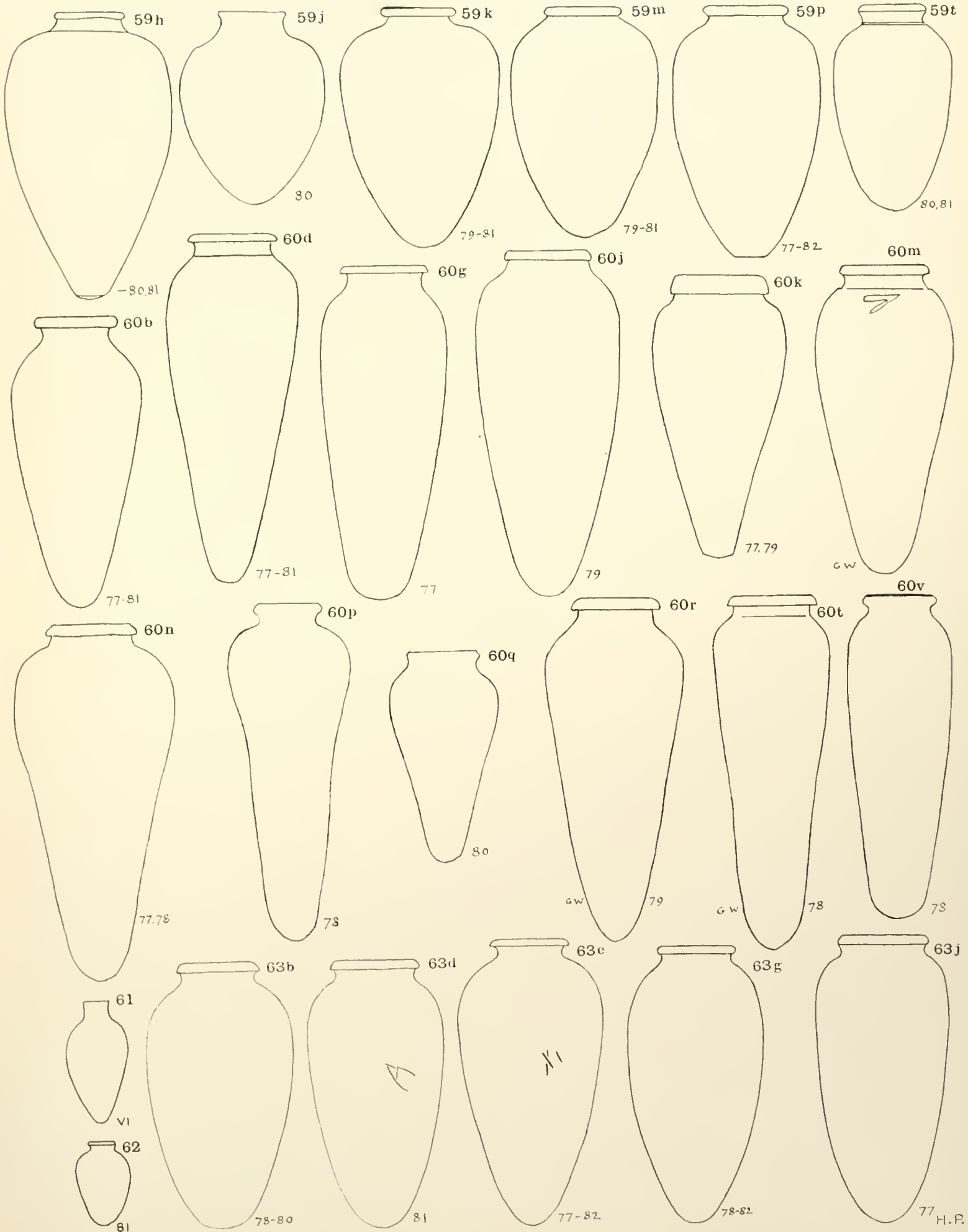

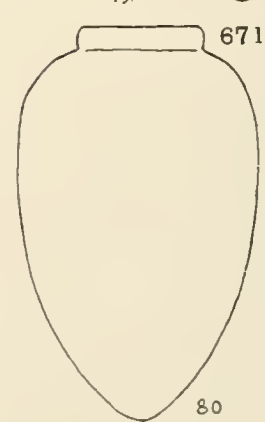
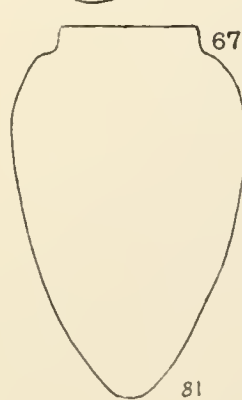
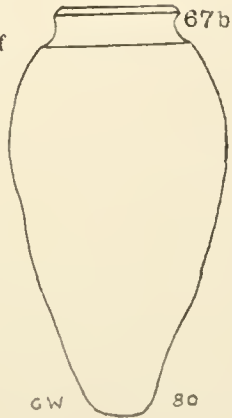
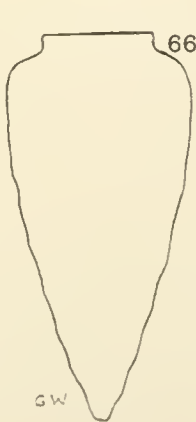
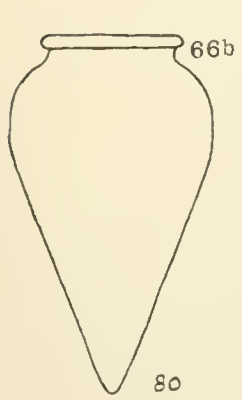
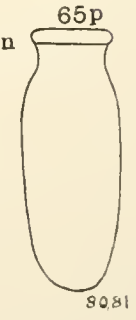
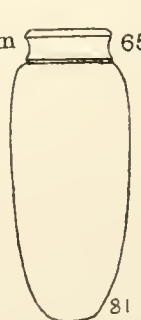
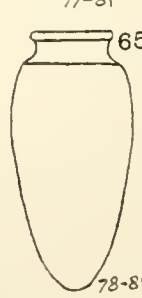
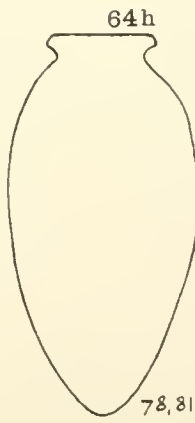
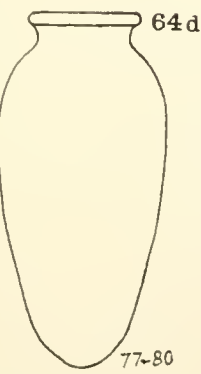
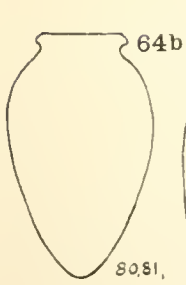
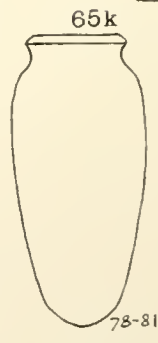
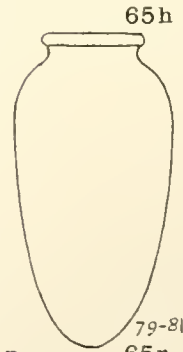
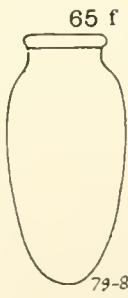
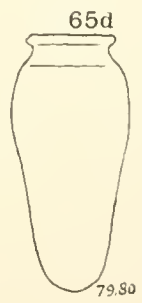
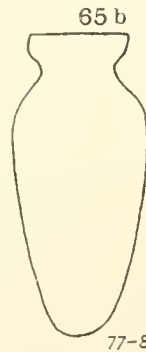
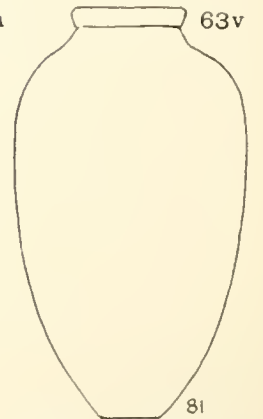
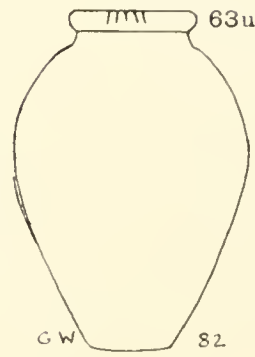
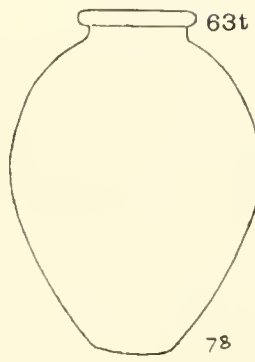
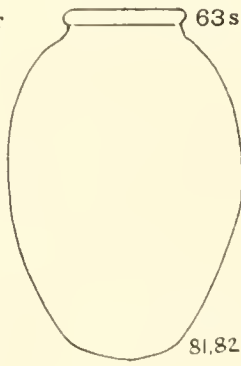
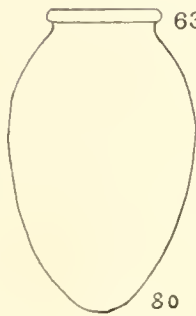
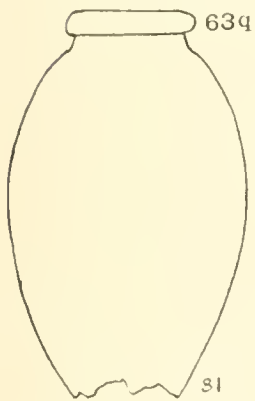
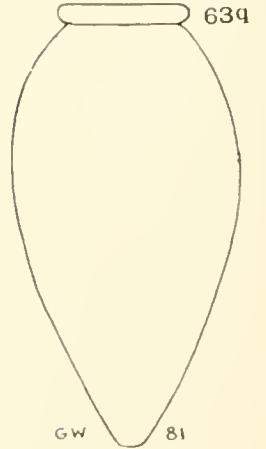
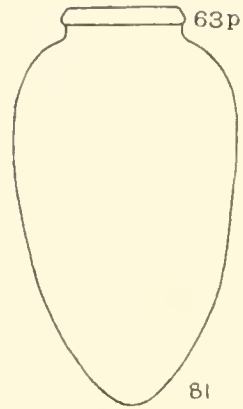
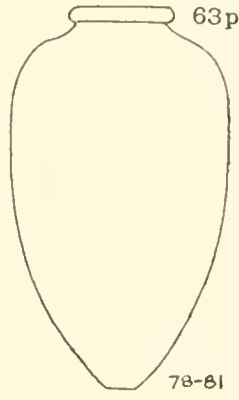
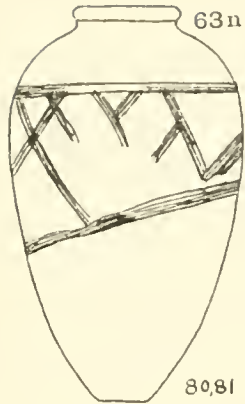
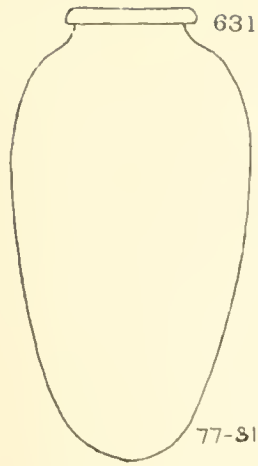

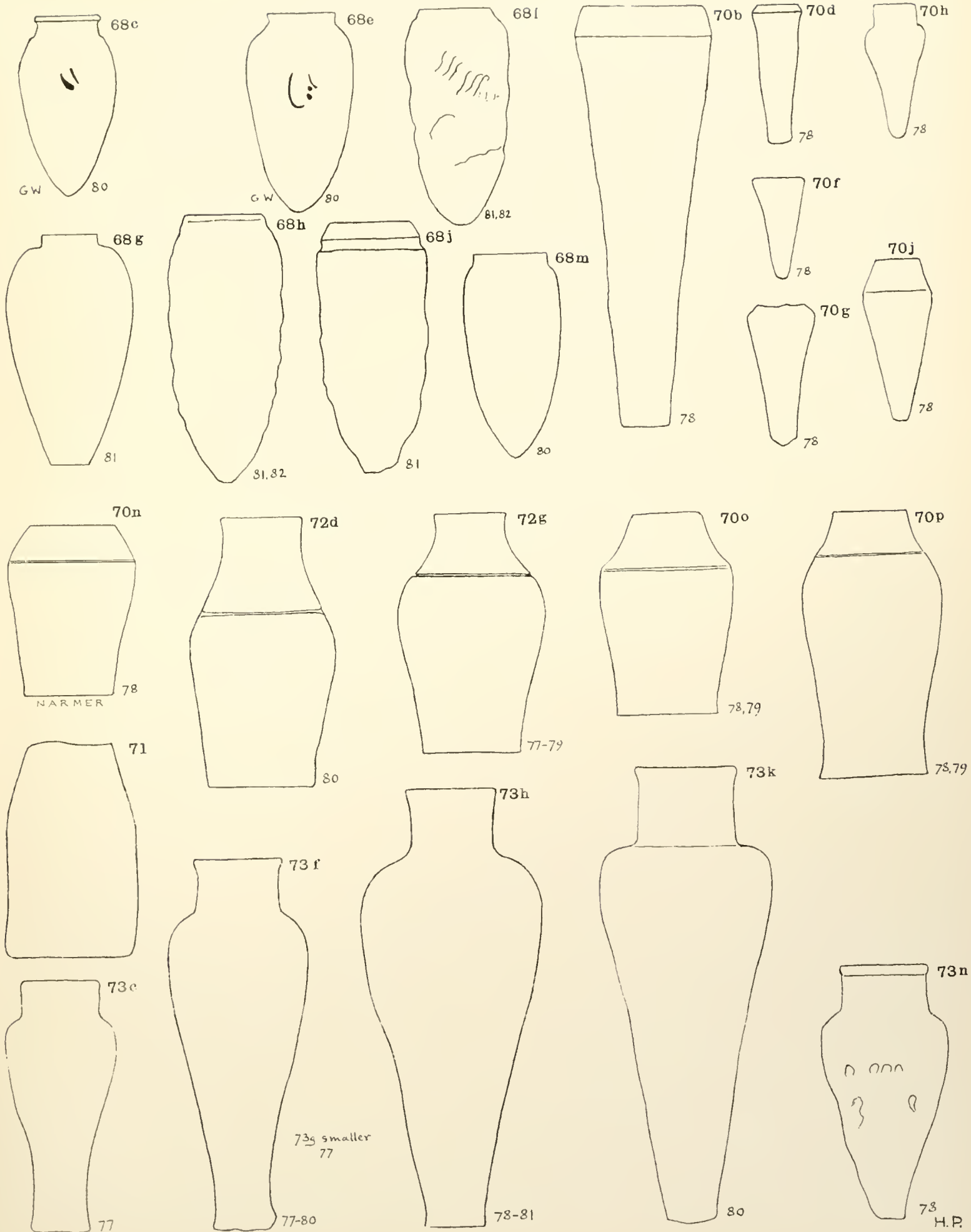

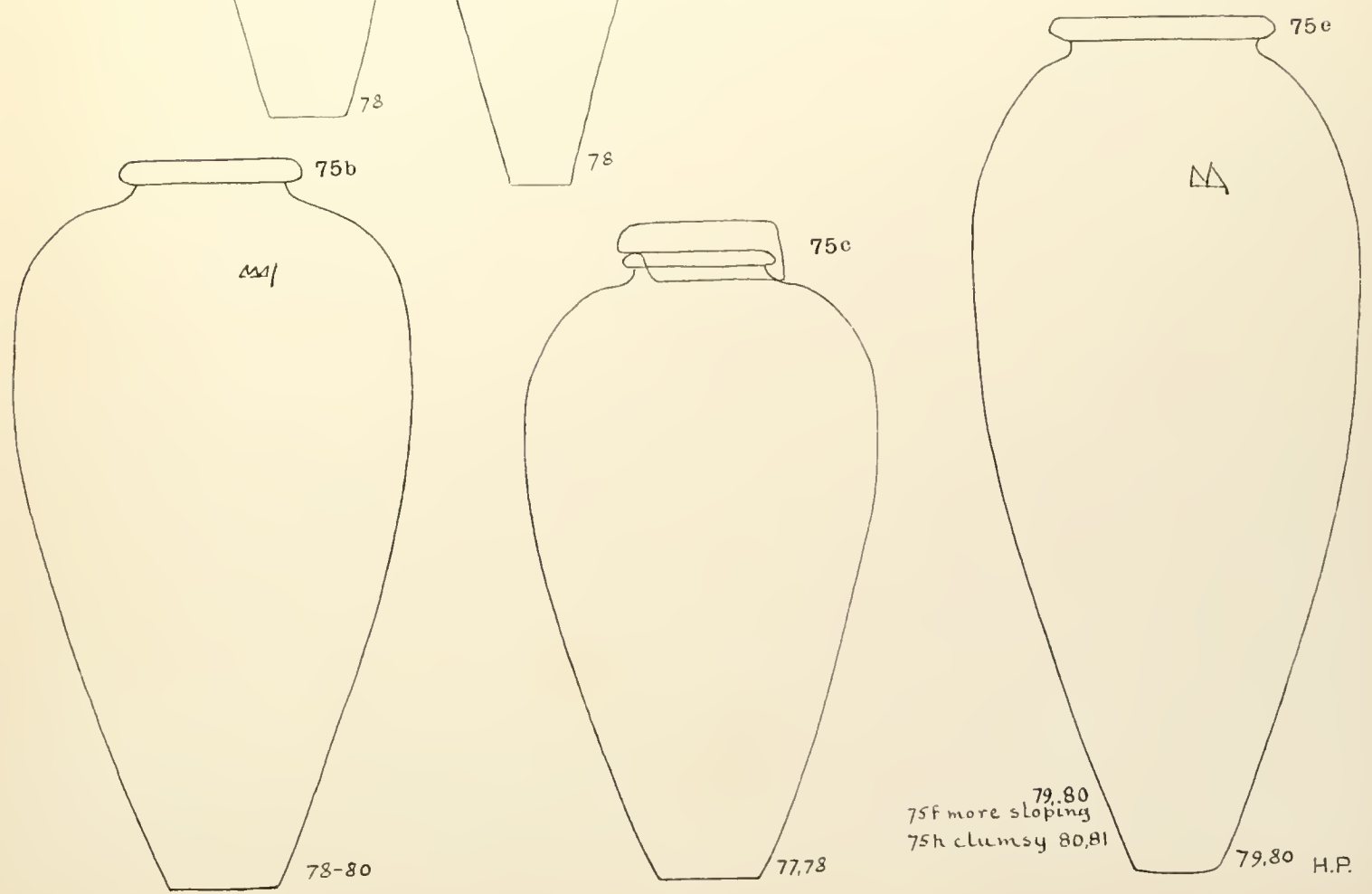
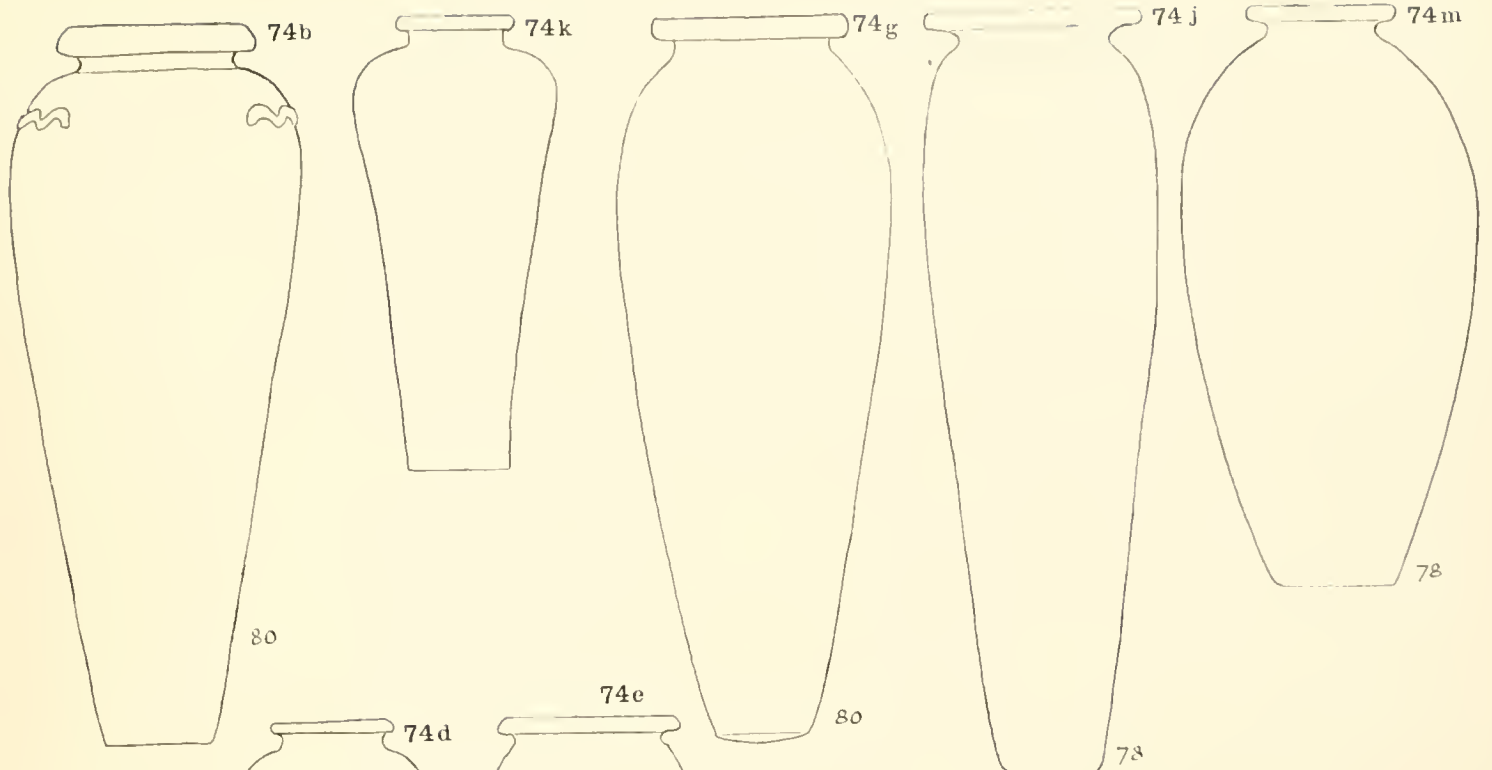

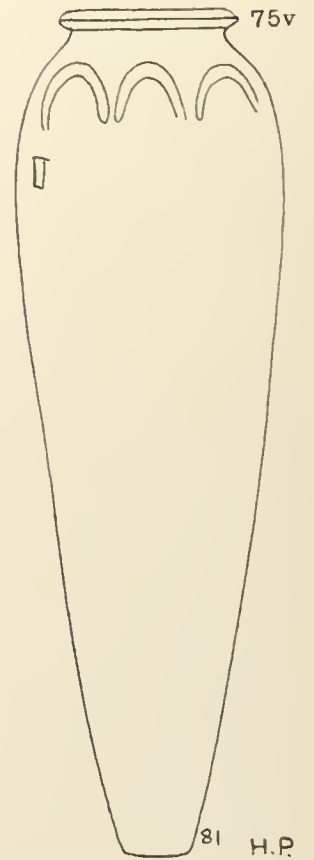
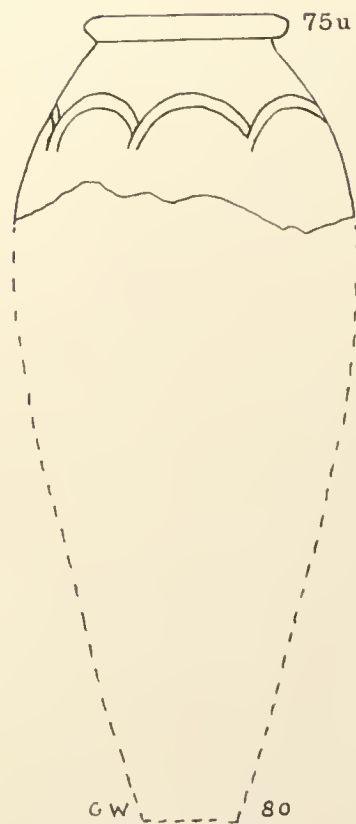
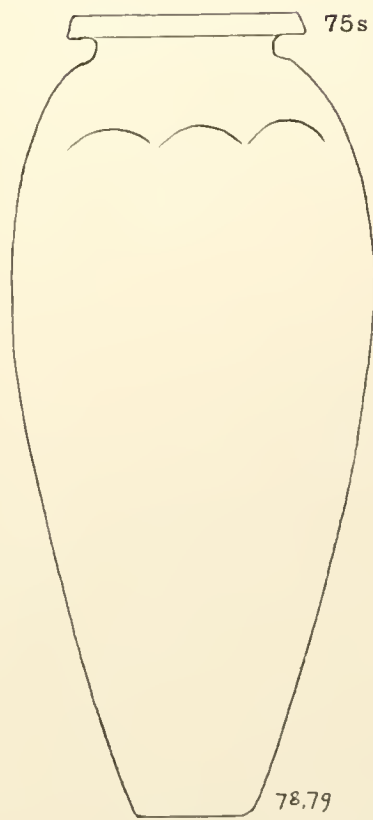
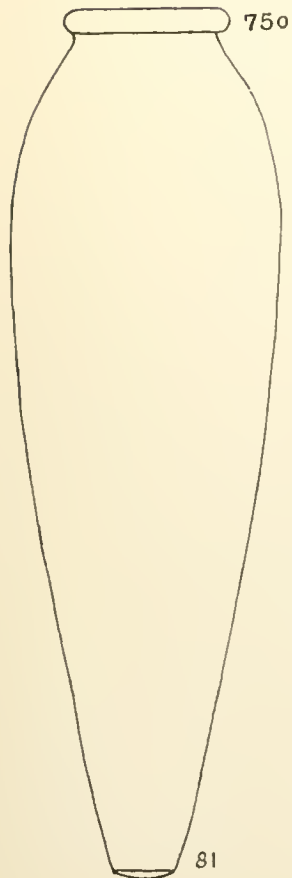
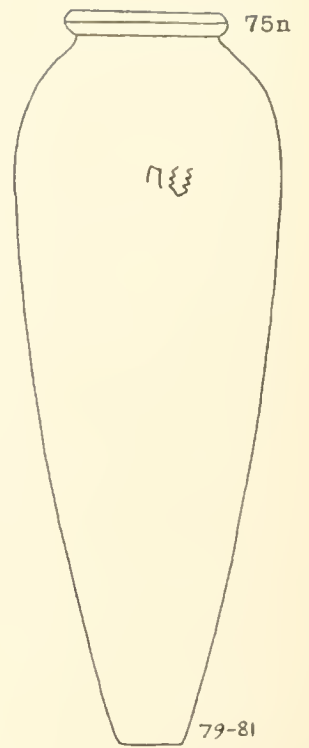
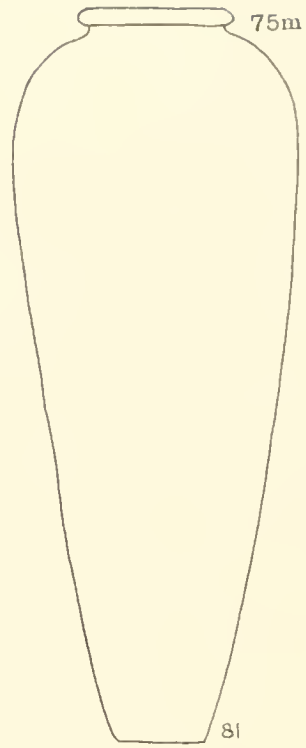
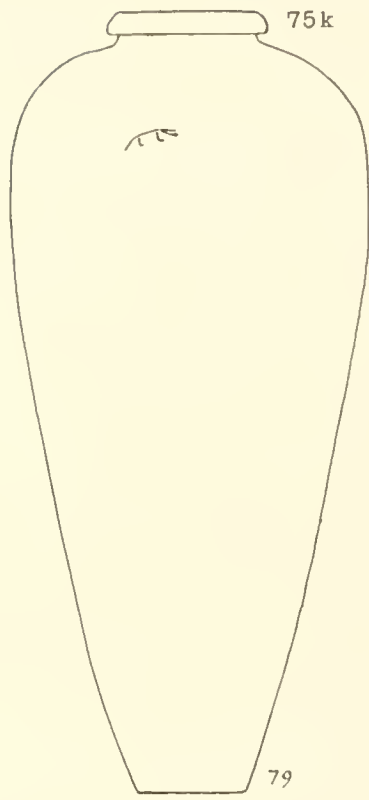
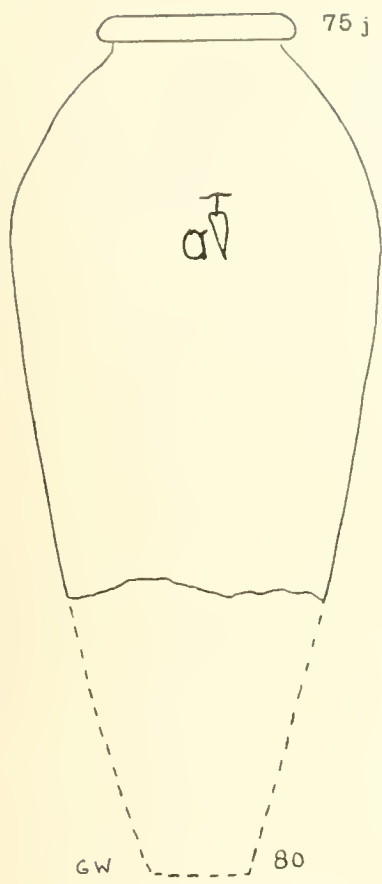

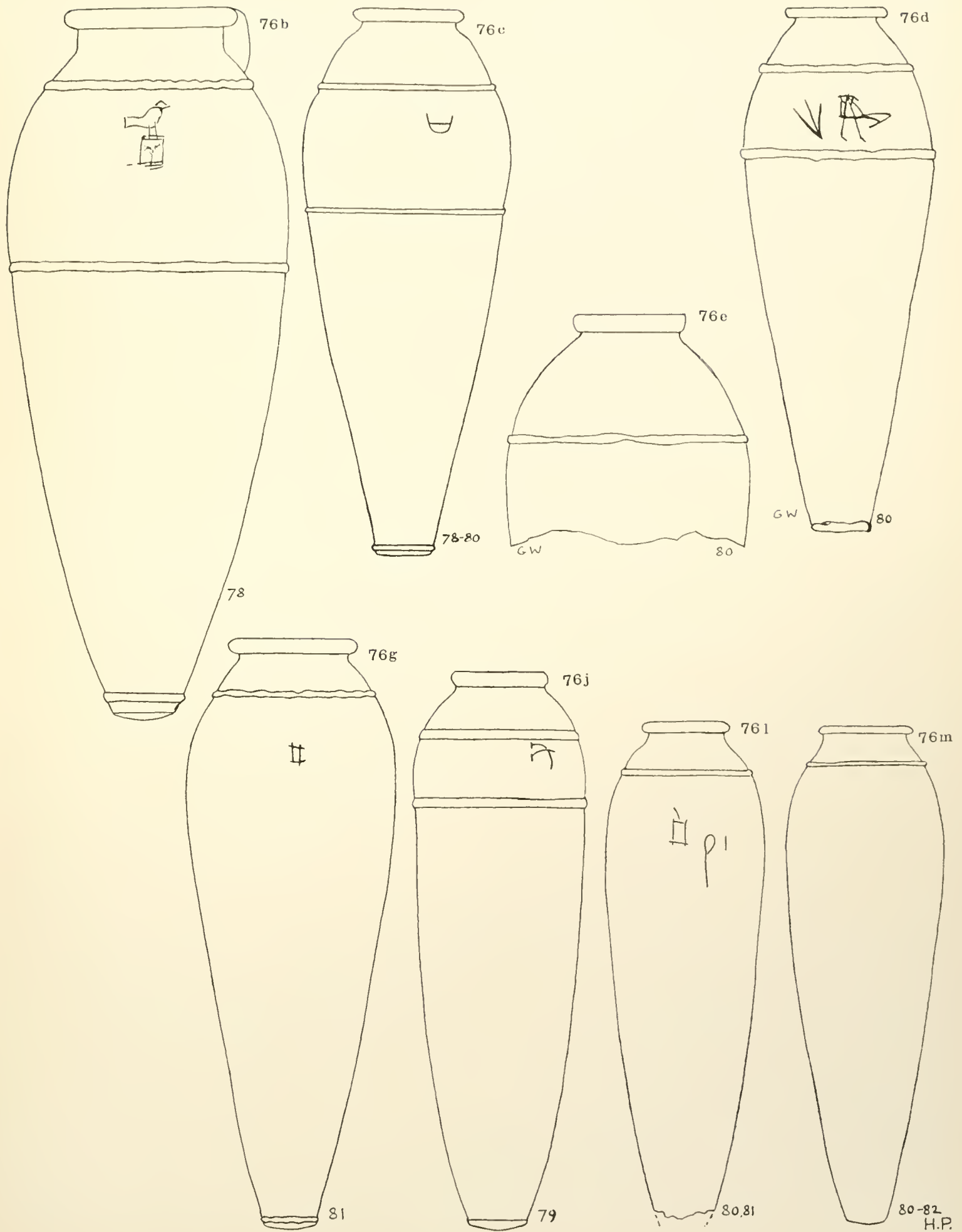

76b

76c

76d

76e

78-80

GW

80

GW

80

78

76g

76j

76l

76m

81

79

80,81

80-82
H.P.

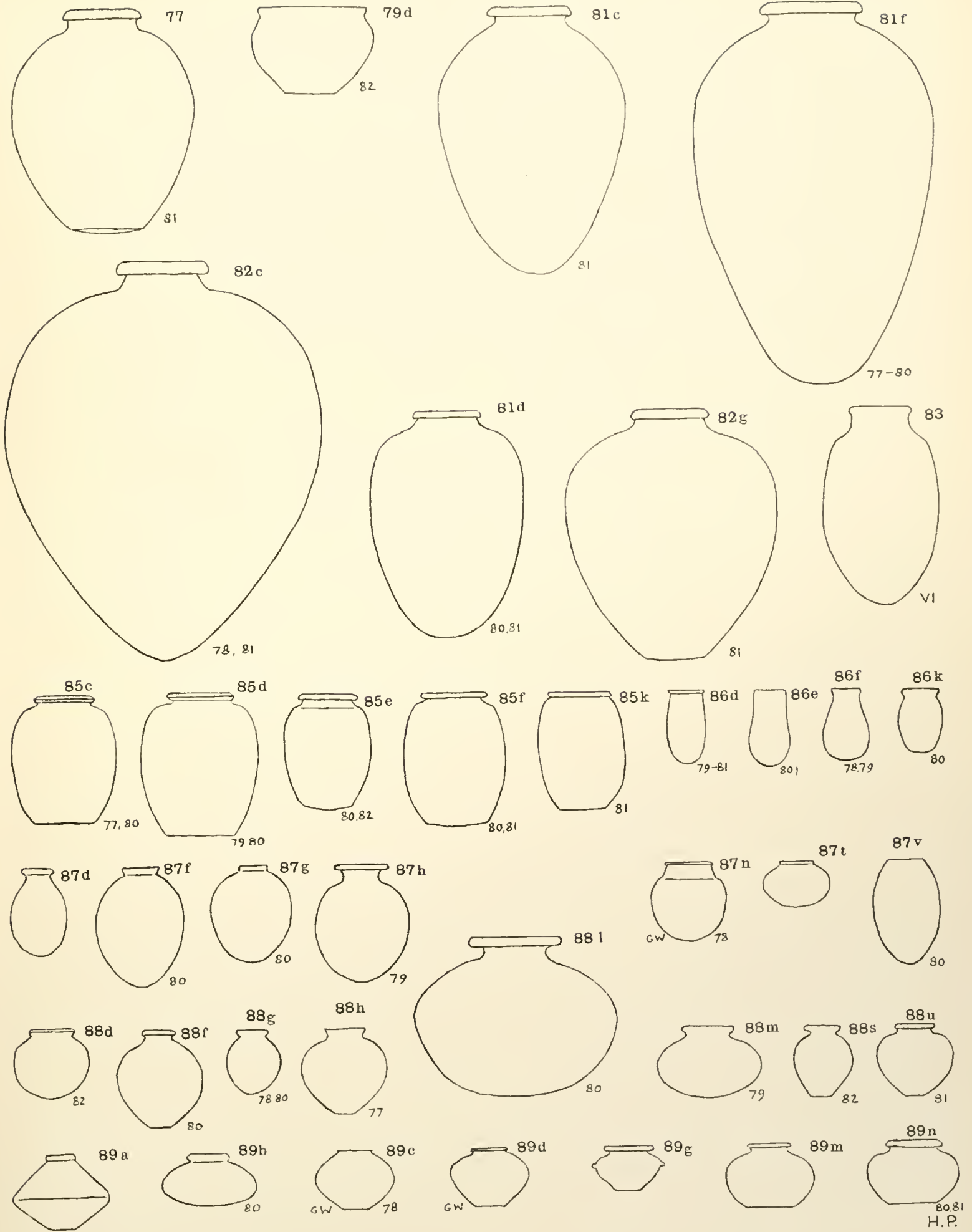

TARKHAN. POTTERY. 90-99.

1:6

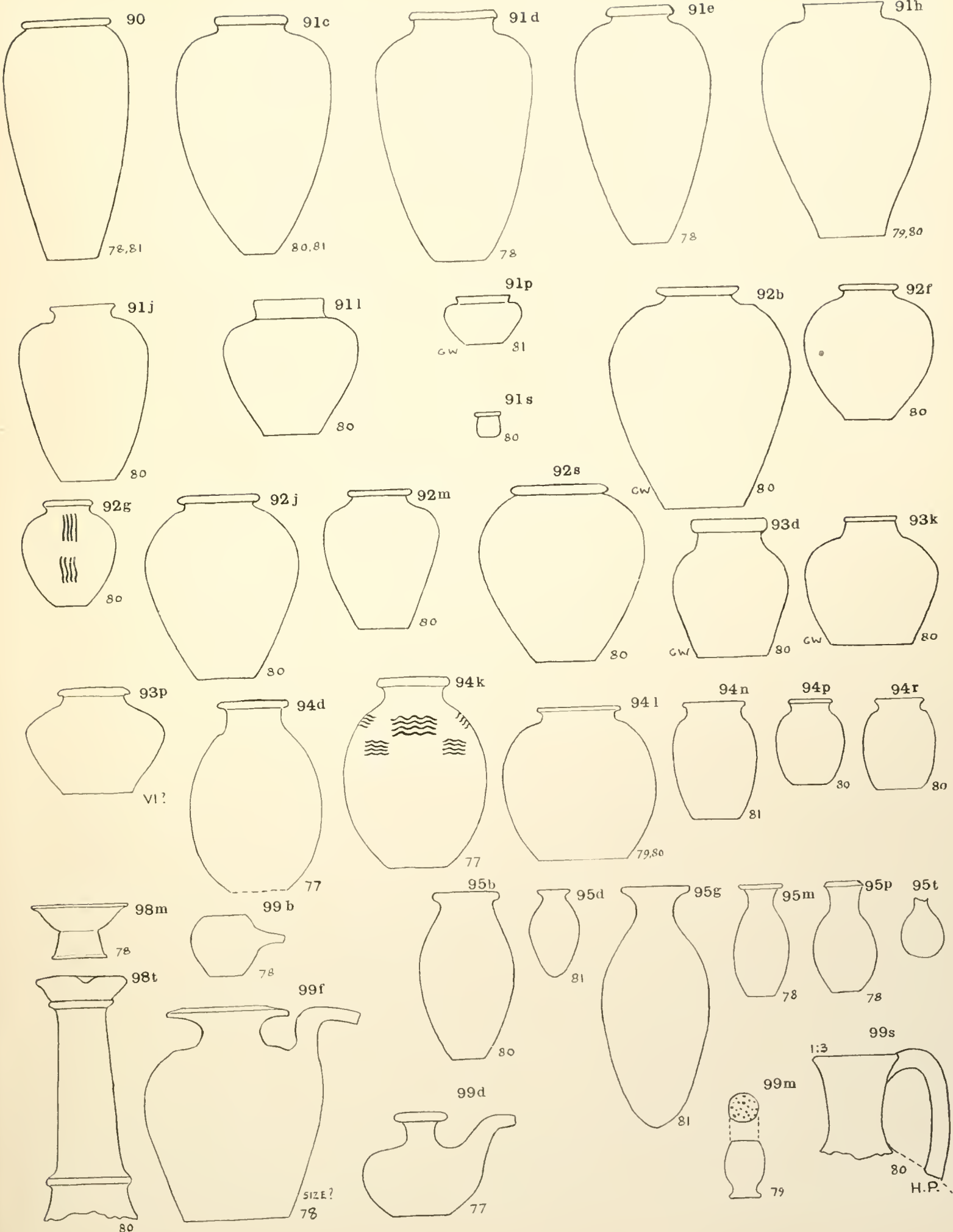

No.	SIZE OF GRAVE	BODY FORM	HEAD FACING	SEX	P O T T E R Y					STONE		COFFIN	BASKET	MATT	BED	COPPER	BEADS	OBJECTS
					DISH	BOWL	CYLINDER	EGG - POT	BIG SHANK-BASE	SMALL JAR	NECK							
6	36-72-30	S			3b	46bft	47p	59h	73f									
18	63-25-20		W		3b	46bdprw												
30	FITTING COFFIN					46bfhm												+ GREEN GLAZE
40	50-103-55	L			12t	46b		60b										+ SAPD
53					3b 14d	46dhkm		60bdgk, 63j				24c	50d					2 FLINT FLAKES
57					3b 14d 20b	46b		60d										
65						46d				81								
71	30-70-40	S				46bdhkm	56f, 60d											
73	30-60-25	O				46d	56f, 60bd			99d								
74	50-90-30	S			8	46bdfm	60d											SLATE
81	30-60-30	S	W	F		46b t					26d	73g	0					+ GARNET SAKDGM
85	30-70-50	S			3g	46 m				81		71j	+					SLATE
86	30-60-15	S	W	F		46 f	54s				15l	71w	47-23					SPHOON
92			W	N		46 k							47-24					
141			W	N		46 p	57n-t	65b		85c			+					
144	45-80-46	S	S	E	4 17b	46 b	50b 59b	65b					81-39					WOODEN TRAY
183	30-70-40	S			12y 19f	46 bdf		73c			24g							AND DIPPER
186	50-30-25					46 d				92g								BL. CARN.
306	35-60-33	O	M		12hy		59p 60n				+							
307			W	N		46bd		64d					51 22					
308	25-48-30	S			4	46b	59p						42-20					
313	45-95-80					3bjsu	46b	60d										
315	60-120-55	S				44c	46bfk	60d				51c	77d					
318	33-75-38	SL				46h				94dk								
319	25-65-35	S	RECESS			46dfh	47d	56b	65				71t					
527						46dh		60bd	64		9w							WOODEN
542	25-33-16	O	S	W	M	46 f		60b										TABLE-BOARD
802			S			46 f		60bd	72g									
804	40-72-60	S			3g	46dfh		60d	65	88h								
1006	64-151-95	SL				46b-h			75c									
1015	52-27-30	S	S	W	M	46df	56d		76		11c		+					ADZES
1037	34-73-40	S				46dfh	56d	60k										AXE
1048	34-53-22	S				46df	56b	63e										FLINT KNIFE
1055	36-68-40	SL			36j		60d											
1062						46dhk	60k											IVORY SPOON
																		PALETTE

CONTINUOUS NUMBERS IN ORDER OF REGISTRATION. DIMENSIONS OF THE GRAVES ON NORTH AND EAST SIDES AND THE DEPTH IN INCHES. FORM SQUARE OR OVAL OR LINED WITH BRICK. DIRECTION OF HEAD AND FACE. SEX MALE OR FEMALE.

TYPES OF THE POTTERY ON PLATES XLVI TO LVIII,

APPROXIMATELY SORTED IN COLUMNS SO THAT ANY TYPE NUMBER CAN BE QUICKLY TRACED OUT.

TYPES OF STONE VASES ON PLATES XXXII TO XLIV.

COFFIN LENGTH BREADTH DEPTH IF OF WOOD, + IF ONLY FRAGMENTS, OTHER MATERIALS NAMED + IF BASKET AMONG OFFERINGS + IF MATT BY BODY OR OVER GRAVE + IF BED FRAME FOUND COPPER TOOLS NAMED IF FOUND + IF BEADS FOUND MATERIALS OF BEADS OR OTHER OBJECTS FOUND IN GRAVES.

No.	SIZE OF GRAVE N. E. D.	BODY FORM HEAD FACING SEX	POTTERY					STONE.		COFFIN L. B. D.	BASKET AND MAT	BED	COPPER BEADS	OBJECTS AND MATERIALS
			DISH BOWL	CYLINDERS	SHANK	BIG EGG-POT	SMALL NECK FLAT BASE JAR	DISH BOWL	JAR					
15	118.94	L												
17	26.43						60d	70j						
19								70f						
25	33.73	L	3f				59h							
27		SW		36g				47p						
30	22.31							47p						
34	37.55	L						47p						
36	33.57	L						46h						
38	27.51	L						47p						
42	51.94	L	3k											
44				36gn										
47	20.31							47p						
48	42.63			36gn				47p						
49	22.35							47p						
53	49.95	L	3k	3og										
54	29.31							48						
57	30.39	L						47p						
58	31.43			3fg				47p						
64	47.63	L		3f				47p						
84	35.39	NE		13m				47p						
89	43.51							47p						
90								47p						
91	39.63	NE	3fk	14e				48						
95	30.43	L						47p						
99	39.71	L		3g				47p						
101	23.39			3f				47p						
109	57.39							48						
110	35.27	NE	3f					48						
113	33.39			9h	14y			51g						
117	35.55	NE	3l					47p						
120	20.29	SW						47p						
131	26.28			3fg				47p						
139	26.37	NE	3l					47p						
158	26.43	NE						50d						
159	31.45							50d						
162	43.67		3k	14j				47p						
164		L		14e				47p						
172		L	NE					50d						
182	25.43	L		14e				60n						
204	43.98	L		3f	14e			60n						
205	24.45							60d						
215		WN	3k	19v										
236			1x3f					50d						
241	28.40			3f										
266	55.63							63g						
273	35.51			3g	14e	27r		50d						
311	27.37							19v						
356	33.51	L	NW	3L	11d			50d						
403				3m	27r			50c						

No.	SIZE OF GRAVE N. E. D.	BODY HEAD FACING SEX	P O T T E R Y				S T O N E		COFFIN L. B. D.	BASKET AND MAT	BED	COPPER	BEADS	OBJECTS AND MATERIALS
			DISH	EGG-POT	BIG	SMALL	DISH	JAR.						
			BOWL	CYLINDER	SHANK-BASE	JAR	NECK FLAT BASE	BOWL	JAR.					
1	41.74.36 S		17g 29d			59hkm 65dflmw				62.26 TRAY				
5	33.85.40 S		18k			56bh, 59	76j							
12		SWM	12t 18b			54k 63	8589h							
19	45.92.55 S		3b	47p 49dg			73h	19j	73h	+			+ CARN-LAZ-GOLD	
21	66.82.40						73h						IVORY SPOON, KNOBS	
52	55.90.50 S		2b, 9, 27p		50			25j		+			SLATE	
54	40.80.50 S	WNF			50f	63g	75e 76c			+	+		ROUND SLATE	
70						60b								
108	40.92.120 S					55 60d 63ge	76c	13p						
111						59b			54n					
116	40.60.45 S	SW				59f				40.20 TRAY				
125	35.76.45 S	SW	7d 33n			59p	99m			50 15.22 2				
140	40.65.50 S	SWM				59p				TRAY	+			
147	20.70.50	SWM				59b				TRAY	+			
151		SWM				59b								
156	60.70.40 S	SW	18b 29d			57n, 59p 63g 65k								
157	70.80.70 S	SWM				59mp 65bw	76c			40.20.20	+	+		
161	30.65.55	F	12n 13g			59b 63g	85							
166	25.50.40	NW				59b				TRAY OF 30 BRANCHES				
168	42.85.65 S			48gs	50 57j	63g 65fh				50.24.15				
172	30.70.40 S	SWF	1f 29d			65k	85d			53.18.15				
175	55.120.50					59b 65w				43.12.10				
179	45.70.75		11b			59p								
195	45.41.47 S		1d	46bf		56f 60k 63g	75e						2 SLATE	
201	24.35.46 O	SW	18b 27g			57t				O BASKET				
203	36.48.60 O	NE	12n			59b				37.14.10				
228	41.49.53 O	SW				59p				O BASKET				
278	56.32.14 S	WNF				63e 65mr							HORN SLATE & IVORY ARMLETS	
279	29.62.36 S	SWF				59p 63e					+			
290	68.42.36 S					60t 65f								
291		O SW	19f 20f			63								
292	38.60.60 S	SWM		49L 50		60d		6h						
304	35.70.40		16f 47p 48g 49d			60j	75kn							
327	35.55.40 S					60d	73f	81f						
*336		SWM		49		60d							SLATE	
402	24.59.48 S		16d			65m								
404		L NE ch	1x			65w				MAT LINING	+			
411	30.39.58 O	SW F	1w			60b								
423	36.58.41 S					59m 60d								
474	48.84.72 S		18f 4b			60dk		14n	71L				IVORY SPOON	
501	28.60.48	NE F						14k					SNAKE SPOON	
1003		S	13f						62e				ROOF POLES	
1005	37.71.24 S	NE	12L 20d		54u	65f			BASKET					
1009	32.49.49 S	NE	12t 20e			63gl			78L					
1010	32.57.63 S		20e			64d							POLE ROOF	
1014	34.40.20	NE?	20e			63e								
1045	61.103.100 S		47h			63e	75-6	9hj	21mw, 55f, 62p					
1049	25.70.40 SL						75b						2 BLUE CYLINDER	
1052	52.103.60 S			49d	59f 60r	73h 75b 76j								
1053	54.140.67 S		46d, 47b, 49d	49d	56f 60d	73h 75b 76j							FLINT FLAKE	
1054	57.192.65 S		47h			75b		7c 18f, 19h					IVORY SPOON	
1061	66.175.70 S		46dh 47kmps 48dgt 49d			72g 75b							DRAUGHTS MALAC' CALENA	

TURAH, JUNKER.

43		NE		47p		75e	91h						
122	27.39				57f	70op	91h						
177	39.68	L	283k 11d	47p		75s	86f						
186					50d 59p	75s							
193	22.37	L	2b		51k	70op	76c 90	24L					SHELL
197	49.69	NE	3g	47p		75es							
216	43.59		3f 11d	47p 51dk									
222	55.79		3k 11d	46h									
223	47.87	L	14y 27h	47p									
230	39.61		27hr		50d 59p-63g								
288	37.71	{ NE WN	3k	27h		63g							
293	35.67	L			50d		75e	19c, 24L 52b					
307	43.25		3k					13p		+			
335	35.47		3g		57f 63g						+		
361	22.37		13m		57f								
470	22.51				59p 65w			64g			+		

No	SIZE OF GRAVE N.E.D.	BODY HEAD FACING SEX	P O T T E R Y			S T O N E			COFFIN L.B.D.	BASKET AND MAT	BED	COPPER	BEADS	OBJECTS AND MATERIALS
			DISH CYLIN- BOWL -DER.	EGG -POT SHANK-BASE	BIG JAR	SMALL NECK FLAT BASE	DISH CYLIN BOWL -DER	BARREL AND SQUAT						
2	22.48.16	SW	29d	65tk	85c					+				
55	25.45.20		19u 3bce 50							+				
60	65.80.40	S	27h		9ls	23f 24e jr	IVORY 53g		TRAY				3 FLINT ARMLETS	
62		WNF	27p 3bct	59f 65f					+				GALENA	
80		NEF		63lp	85f	14d, 22b, 42k	77m 78ek, 81t				+	+	GARNET, CARN. ST. RYMER	
91	45.60.50	SWF		59k 65k										
93				59h 65t	85c									
98				65t	85d 89n									
109	50.135.100		16f 20d 50	59t, 60d, 63l, 64d	75-b		53d 55c							
112	45.65.55		2d 19u	65f		11d, 13l, 20p	62c 71e 77s			POLES+				
113	40.85.55	SWF		59ht 65f	75-b 85c				55-20 TRAY					
118	65.110.65			59b	75-b		22d 23k 55n 71c		0			+	FLINT KNIFE	
123	35.80.60	SWM	17g	57k 59h		91e 92j			60-25 TRAY					
127	50.80.50	SW	12h, 19w 25f	56d, 59p, 60b, 65f	75c				65-30-2 TRAY	POLES+				
129	50.80.60	NW	27h	59p 63e		17d			65-28 TRAY	POLES+				
130	50.75.60			59b 63e 65k		7s							SLATE ARMLET.	
135	30.65.55			63e		85d	8t	54y				+		
137	30.75.40	S										+		
138	54.70.60	S	12l 29d	59d 60d 65f								+		
142	40.80.40	S	12n 19w	59h 63b 65k								+		
143	65.90.50	SWM	11b	59t		9p 24j			50-40 BED	POLES+		+		
145	40.75.50	S		59p 65f km					TRAY			+		
149	55.85.50	SWM	11b d, 16t, 36s	63e, 65b k	75-b	8v	53l, 54d, 55k		70-30 BED			+	8 FLINT ARMLETS	
153	50.85.90	S	12w 29d	59d	76m 92f	26l	77s 81r		TRAY			+	RUSH ON WOOD	
154	40.70.50	S	29d 33r	56n, 57g, 59b	92m, 94p							+	BONE AND CARNELIAN WOOD SPOON	
170	90.45.70	WNM	13k 13ad 16y	56h, 57p, 59k, 63e	75-b 86k, 88f, 98t	29n, 51tw, 54hj, 56n			55-19			ADZE+		
171	40.80.60	S	11b d	63b		14h 24n						+		
174	55.38.40	WN ch	14d 29d 50h	65f								+		
177	45.90.60	S	11b 13f	59m, 65h		22v 52d						+		
187	50.80.70	NEF	17g 20h	66b			62g 78h 80c					+		
192	50.80.90	S		59m, 63g, 67l			62g		44-22 17					
195	34.61.47	NEF		63n		9b 13m	62p 67y		33-18					
198	25.50.60	NEF	19u	64d			78g		BASKET					
204	60.80.36	WN	27d	59t 65k	87v	9f 22v 54v			REED			+		
230	60.90.54	SW	12l 16t 46k	59m, 60b 63l	74d	23t	62g, 77k 81n							
257	17.28.18	SWF	25d	59b d f	85d				2-20					
258	30.53.24	SWM	12p 17l	59f					+					
			14d 29dm											
281	30.58.24	SWF	29 50	60b d					41-19 TRAY	POLES+				
282	21.43.37	SW	24s	64d					0					
284	46.84.60	SWM	13k	59t 65k	95b		56k		53					
287	28.54.37	SWM		66b	92s				35					
295	34.60.32	SWF	29d 50m	63gr										
296	40.60.42	0	50	59m										
298	36.66.60		50			14b								
300	45.90.70		19w 27p 38r	63l										
312	31.50.41	S	46d 50		74g				BOARD LINING BASKET				2 SLATES	
401	29.48.48	SW	50	60b										
407	35.62.72	SL	49L 50											
410	70.39.36	SWF	17h 24f 31	59b										
415		SWF	48L 49L 50			14s	61l 72c		33-19			+	CARN. CRYST. METH SLATE	
417	60.38.43	S	3d 24f 31	59b 65					+				BED OVER BODY. 2 SLATES.	
419	39.60.44	S	50	63e, 65h, 72					0			+		
421	34.60.39	0	17l 24f	65b					0				IVORY ARMLET.	
422	72.34.50	0	24f	60b					0					
477		SWF	49g 50	60d					42-20-12					
523	50.64.49	SW	50						+					
538	40.72.58	SWM	50						47-26-11			+	2	
544	37.62.24	NE	50	63p 73f								+	WOOD BOWL	
900	35.57.40	S	50	65h					TRAY			+		
902	35.50.20	SW		60b 65dk								+		
1013	20.29.35	SW ch	13f		91l	42f 61k						+		
1026	45.63.44	S	49g 50		75be	63 18h 51n							SLATE	
1036	30.43.58	NEF		63e										
1044	24.44.16	NEM		63eg	87v									
1056	40.32.30	NEF	27s 28	63g										
1057	52.16.26	NEF	12l 20d	63g					PAPYRUS BOX					
1060	102.186.89	SL	{ 4 17c 24m 12d 19g 37e	56f, 59h, 67t	75jou 91c 93dk 8g 21g 53k 62m	57rl 64d 68ce 76deg 92b 99s 9hry, 29hj 54li prvw			PAPYRUS BOX					

No	SIZE OF GRAVE N.E.D.	BODY FORM HEAD FACING SEX	P O T T E R Y				S T O N E		COFFIN L.B.D	BASKET AND MAT BED	COPPER	BEADS	OBJECTS AND MATERIALS
			DISH	LYE	EGG-POT	BIG SMALL NECK	DISH	CYLIN- BARREL DER					
169				27h3m									
174	41-61	SW	3k	27h	47p	56p	59p						
179	35-83	L			47p		60d	73h	72eh	POTTERY		+ IVORY PIN	
181	43-57	SW					63g	75e, 81f, 86d	WOOD			PALETTE	
329	40-55			27d				88l					
337	31-47	SW			50t	57ofn	63g	65t					
338	27-67		1x	3k	20h	50t	59p	65t	9lj				
341	40-60	NW		3k	50t			65t	9lh				
342	35-51					57o	63g	65t					
343	39-47	E	3k			59h	64b	65p					
357			3k		50t	56p	59p	65t		WOOD			
363			3L	27d	50t	59g							
364	41-59	L	3k	14L		57f		65p					
365	39-35		3L		50t	59p	65k-t	76d					
366		L	3m		50t			65t	8ld		MAT SIDES		
367	28-49			27d	50t	57o		65t					
369	18-25		3k	27d	50t	57o		65p		WOOD			
371	24-39	SW		27h	50t	57f		65t					
372	33-79					56m		65k-t	76d 8ld 9lh	25c 27g	54n		
391	35-63	NE		27d	50t	59h		65p					
417			3L		50t			68e	75n				
435			3k		50n	56p		85d				HORN ARMLET	
438				27h	50t	56p, 57f		85d, 94L				SAME WITH	
442	30-63	SW	1x	27h	50n		65h	85d, 88g				COPPER TIE	
455		SW		27d	37e	5ld	57o	64b	87g	88g			
456			1x	3f	50t		63g	65k					
460	27-35				50t				24L		64h		
469	31-49					57n	59p		87f, 88g	24L	6lj		
477					50t	57fo	65p						
487	31-43		3L		50n	59p					54v		
490	33-39				47m	50t	57o						
494	31-33					57o	59g	65p	85d				
495	35-67	SW	3k	27h	50n	57v	59h	65p					
496		NE		13m	50n	59p		65p					
498	41-71					56p		65p					
500	37-71	L	3L	19v				65p	75n				
501								59p	65p		88l		
502	51-67		3k			59p	64b	65k					
503	23-39	SW			50n						54v		
505	23-39				50n	56m		65kp				+ IVORY VASE	
518	16-27	L	SW	3k	50n	59h			85e		24L		
525	33-71	NW			50n	59h	65kt	76dl			24L	54nbll	
539	39-55	SW	3k		50n	59p	65p	76dl	13p, 14b, 27g		54nbll		
543	33-53	SW	3m		50n			65p	9t	24L			
548	39-59	SW	3L	19v		57o		65p					
549	67-86	L		27h	31m	57o		65p	85d, 94r	13b	1p		
551	35-75	L	1x		50n			65p	76c				
573	37-63	L		37e		59p		68m					
575	45-59	NE		9h				68m					
576	45-59	NE						68m	89b				
577		NE			37f-n	59j							
578					37f-n	59jp	68m						

No	SIZE OF GRAVE		BODY HEAD FACING SEX	POTTERY				STONE			COFFIN L: B: D	BASKET AND MAT	BED	COPPER	BEADS	OBJECTS AND MATERIALS	
	N: E: D:	FORMIT		DISH BOWL	CYLINDER DER	EGG-POT	BIG SHANK-BASE JAR	SMALL NECK FLAT BASE	DISH	CYLINDER							BARREL
4	42.81.36		S M					85f			77q						
58	45.87.60	S		12bn		59p 73h											
59	30.60.40	S		27h		59bh 67j											
61	35.60.30	S	WNM	11b, 14md, 27f 32		57d, 59b, 60b, 65k			14b		72g						+ GREEN GLAZE
63	32.55.40	S		12dr 33b		63p 68h			23t		62g 78p						
64	40.70.	S	NW	27h		60b, 65k, 67j			21t								
82																	
88			O			59k					78l	BASKET 34.20.28					{ SAUCERS WITH BURNT CHARCOAL
89			S	7b		59p			12d 23v		62r 81t						
90	50.80.70	S	SW	19u		54m, 59h	76l 85f										+ BLACK
97	26.41.20	S	SW	12r 17gm 31d													
100	80.105.70	S	S F	12n		59hk		9lc			72f	TRAY					
101	80.110.75	S				59hmp, 65f, 75n											
105	21.35.48	S	S	12np, 13d, 17l, 19u 27f		60b		85f				BASKET					
107	30.80.45	S		36c		59p					62h	TRAY					
110	50.70.50	S	NEM	18m	48s, 50p	59h	75no 94n					57.46.					
115	32.60.70	S	SWF	12n, 17l, 19s, 27m		56f, 57v, 65fk, 75no			22p			35.20.17					
117	55.80.70	S		1k, 2, 13g 27p		59d, 63d, 64, 75no			8x13hl, 21p, 22l, 23p 53d, 55c			60.18.14					IVORY BULL LEG SCARABS IN POT
120	50.60.40	S		29		57g, 60b, 62, 64h, 65f		95d				40.25 TRAY					
122	52.80.120	S	M			57b					60f	50.24.15					
126	45.65.55	S					76lm		7g 21d 25c			40.25.9					SLATE FLINT KNIFE
131	37.75.40	S		1s, 12d, 13a, 18v								35.20.					
132	50.75.45	S		1stu		59p 65m						35.16 TRAY					
136	50.80.65	S		11b 12bru 19d		59p 75v 77						45.20.10					{ WOOD STOOL AND DISH
146	25.50.45	S	SEM								77q	O					
148	50.140.80	S	SW	7b 12l 16z 33l		59k {75mn 76qL						TRAY					
150	45.65.50	S	SWM	12t		59bhp, 64h						30.20.10					BROKEN TRAY
158				11b 12p 33kl		59bfp, km p 76l 81c											
159	30.50.50			19bd 27g		59fp			34								
160	65.100.20	S	SW	16f		63v, 65t			24p			47.25.19					
162		S	SWM	29d		59b 65b 76	86d				78h						
163				3d 29d		59bp					81hv	TRAY					
165	50.80.65	S		11b 12br 14m		59b, km p, 65m 75no			27k	54t, 62r, 63h, 77m, 81c		TRAY					
167	35.65.25	S	M	3k		59p {75nv, 76m}				61c		30.20.15					SANDAL TRAY, SLATE FLINT KNIFE
169	90.160.80	SL		11b		56d, 59b, p, l, 63e, 76m, 77											
173	30.65.25	S	WNF	20f													
176	45.85.70	S	SWM	11b, 19w, 20f, 25h 33k		50s, 56d, 59hmp, 75n 65p, t			12g 22j 31			45.18.11					FLINT KNIFE
178	55.80.70	S		12d		59tp, 65h 76l 85f			14v, 22d, 25m, 31, 56d 78h, 80f 14m			39.24.15					BL
180			ESch														
189	30.75.50	S	SWM	12p, 17l, 27p		59bp, 65m 76l					81bk	39.23.23					
191	40.50.40	S	NECh	12p 38		63l			42p	62h, 77q, 78g, 81v		24.13 BASKET					
194	36.50.55	S	NEF	20k		63e				77n, 78s 81v							
199	30.55.40	S	NEM			59f			22l								
200	31.48.48	O	SW			59p 63n		89n			78h, 81hv	REED BASKET					9L
202	32.41.48	S	SW			59b			23c								
212	37.65.67	O				59bp, 63g 75-6			19s 21p	53c, 54n, 60b, 62r, 77hng		50.18.18					FLINT ARMLET
213		O		14j		59bpm, 60b, 63e, 75o 65, 65r, f		95d	9dy, 13f, 22f, 24r, v		62s	45.25.24					SA BOX
219			NE			60b			8n, 9v, 10l		62egh, 76h, 78m	32.19.					
231	36.60.60	S	NE			59mt, 60d			8k 24t	62ehl, 63m, 78ru							
238				37l		68hlj			42g 62c		81t						
240									42d, 61h, 62h								
249	39.63.38	S							8r 22j	62w		36.18.					
250	26.57.42	S	NEF	3k 16w, glazed		60b		90	5.7k, 22m	62w 73d, 78hr		38.16.13					
269		S	WNF			65			8k 18t	72b							
280	24.39.34	S	NWM			59b 64h					81t	RUSH BOX 30.12.					BLACK, BLUE AND WHITE BEADS + SLATE, IVORY, HORN ARMLETS.

No.	SIZE OF GRAVE	BODY FORM	POTTERY				STONE			COFFIN	BASKET AND MAT	BED	COPPER	BEADS	OBJECTS AND MATERIALS
			DISH	CYL	EGG	POT	BIG	SMALL	DISH						
			HEADING	NECK	FLAT	BASE				-	B	D			
283	33.60.27	S	SWM	24f	5g	38u95g	22n27c	54n		0	+				
294					50d		21n	62p		0					
297	34.72.96	0	SWM		59k60d	64h	76m	82g	90	23t24l	54t				
301	52.65.65		NW		63g		22t	25s		78n80t					
403	34.48.48	S		13g	60b										
481	39.77.54	S	SW	12n	29d	46df	59c	60d	65k	77q81h		0			
512	52.48.56		recess				9n	22y	23k	61p		0	+		
1000		S		20e	54	65k	22	23r		80m81t					
1002	35.64.40	S			65k	65k	10p	14p	25p						
1008			NE			65k	81p	77g	78m	78m		0	+		
1011	53.46.36	S	NEch	12r	20e	63e						0		QUARTZITE GRINDER	
1012	33.58.50	S	NEM			63g		42f		81j		0		CHISEL	
1016	38.59.39	S	SWM	12t	20h	25d	51m	63gl		13b	62gh	81dt	0	POLES	
1017	35.55.48	S	NEM		13g	63el	5	13r	22h	78c	81rt		0		
1018	26.33.63	S		12l		57y		13h					0		
1020	30.60.78	S	NEM	12t		59p	63g			24v	62g	77m	78gr	81t	
1024	36.67.72	S	SWM			59p	63g	6r	13t	22v	24v	62h	78p	81hr	
1025	40.63.37	S	SWF	13f	20e	25d	54u	63gl		54f	62e	71g	77u	78l	
1027	32.52.65	S	NEM			63p		10d	13p	62hv	78l	81r		0	
1028	30.54.82	S	SW	12v	18bf		85k			80p	81r		0	POTTERY 29.10.13	
1029	37.61.59	S	NEM	4		59m	63gp	5	6u	8c	22l	24t	62q	77g	
1031	38.54.75	S	SWM	12l		59m	63gp	82c	6f	19t	21p			0	
1032						59m	63s			61d	62b	81r		0	
1033	37.49.36	S	NEM			63g		6u		78n	81x		0		
1034	43.89.79	S	SE M	12h	lp	27f	63g	85k	91p	23h	62g	63d	78s	80k	
1035	28.52.30	S	SE M	12l	16j	20e	59p			81m			0	CLAY	
1038	29.55.67	S	NE F		20j	59p	63eg			23p	62p	64f	81ht	0	
1043						59p	63g			13v	24pt	71r	80p	0	
1070	32.54.36	0	NE F	12l	20e	25s	59p	63g	85k	91p				0	
TURAH, JUNKER 81															
344	59.163	L				50t	59p	75n	76lm						
370	24.35	L		13g		51d	65t								
377	30.43		NW	3k		57v	65kp		13p						
423						63g	68g	70l							
474	47.112	L				59gh	76l	81d							
NAGA ED-DÊR, REISNER 81															
1512	84.96.72	L		12l	14j	18k	20e	59p	66b	75p					
1513	128.108.66	L	SVI'	12n		56f	57np	63	82c	9g	13k	14ms	24p	54w	
1514	115.108.120	L			16z	33l	59hm		82c		14b	18d	42f	55k	
1522	POTS UNDER A STONE				19u	57d			85e					80h	
1525	78.99.102	L	NE	17g	19u	59g	6kmp	63s	65pt	76g	77	94p			
1532	82.63.70	L	SW			33kl	59hp	75np		23p	54t				
1581	138.92.120	L				56df	59dh	63	66b		52d	54b			
3016	56.46	L	SW							19g	25c	54lnw	60f	62nt	
3017	96.72.110	L				59h	63s	67j		13k	20p	60k	61p	62eh	
3031	112.90.108	L								14m		60f	62s	77k	
3150	NO GRAVE			13h						13h	3l	77q			
3052	58.35		SW							19ct	54t				
3061			SW							22v		78p	81pt		
TARKHAN 82															
24	40.80.72	S	NE			68h				6q	23k	77k	78k		
155	30.65.40	S		12d	20f	63go	76m								
181	38.50.20	S	SWM			68l									
1019	35.56.65	S				63gsu				2	19c	23r			
1039	23.40.27	0					79d	85e	88ds	13r	20g	81t	BASKET		

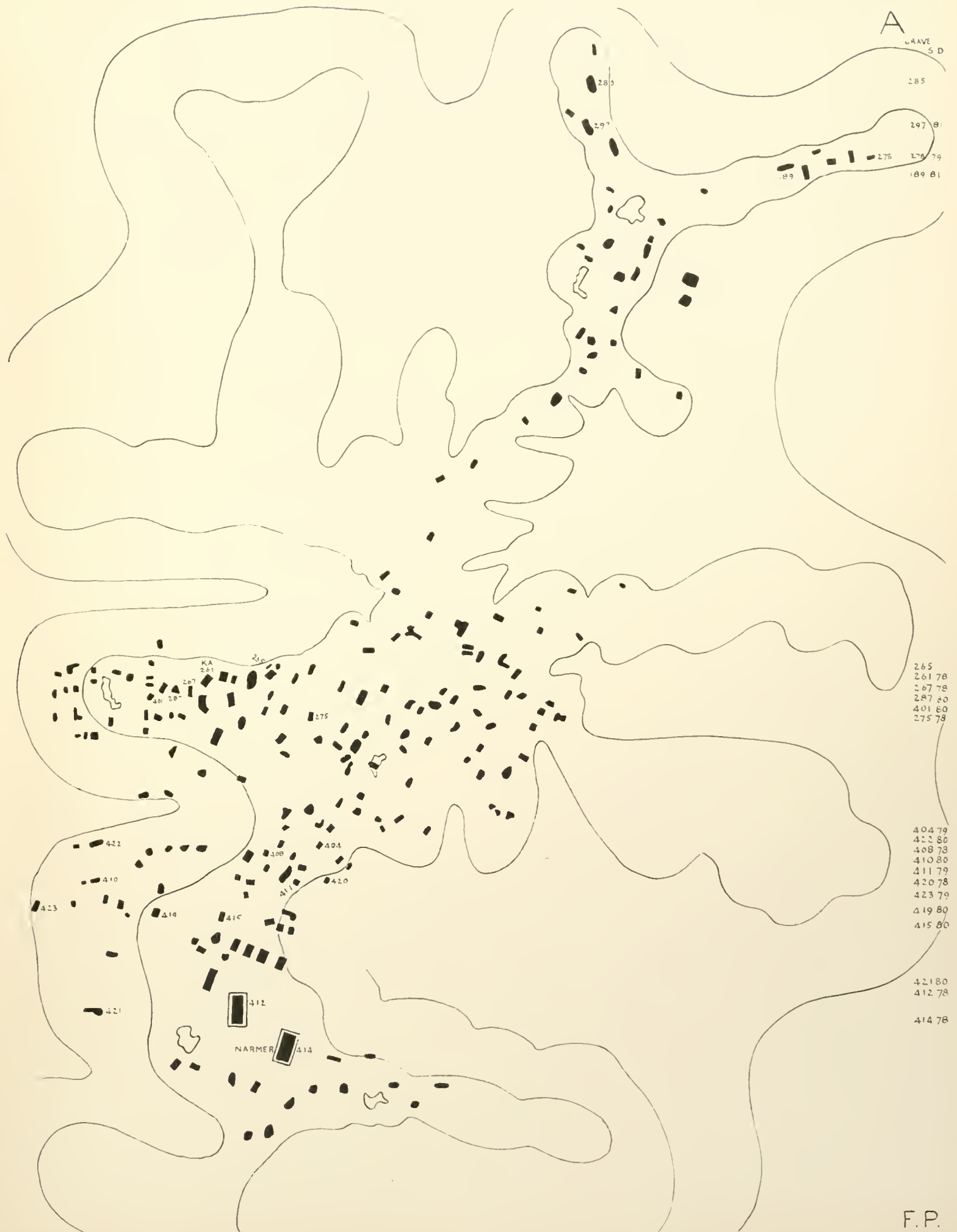



504 77
 503 77
 502 77
 501

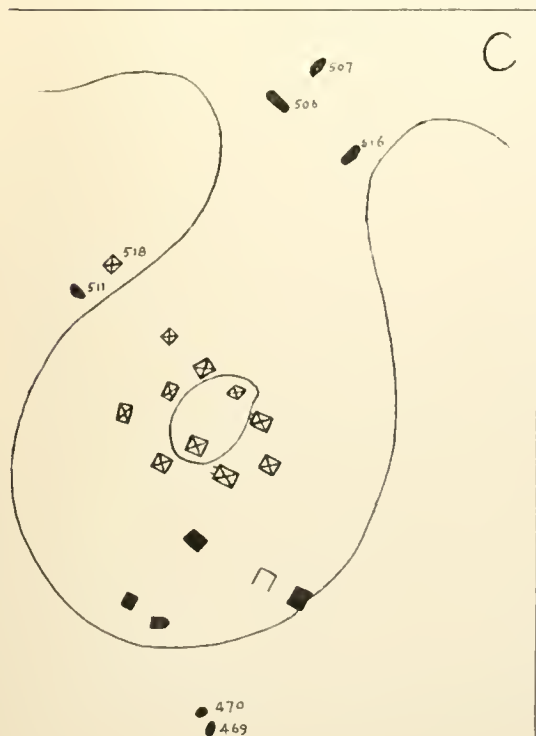

470
 469



FP 470 H-V
 469 H-V

E



95 XI

215 III-V

222 III-V
 467 III-V
 479 VI
 473 XI
 466
 87
 86 77
 225 III-V

215 III-V

221 III-V
 468 III-V
 475
 485 III-V
 32

24 82
 480 III-V

29 III
 216 III-V
 84
 253 III-V

34 III-V

252 78
 465 III-V
 523 80
 241 III-V

70 79
 68 77
 527 77
 525

F.P.

F



GRAVE	20	39	26	38	37	19	16	12	15	5
S D	78	78	78	78	78	78	78	79	78	79

G

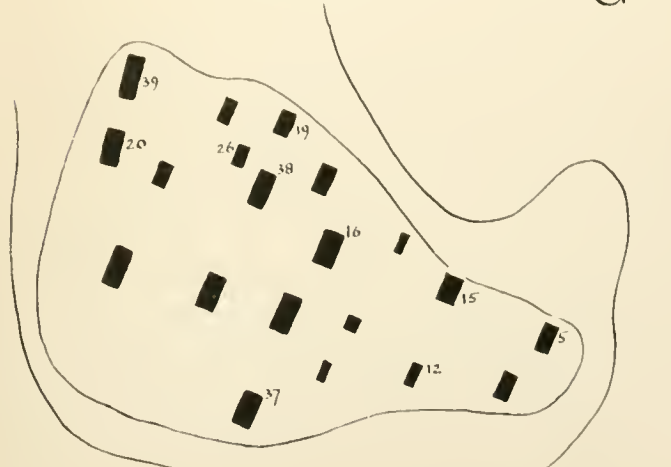

91	900	901	90	350	902	903	13	2	11	1	3
80	80	78	81	80	80	78	80	80	79	78	81

H



F.P.

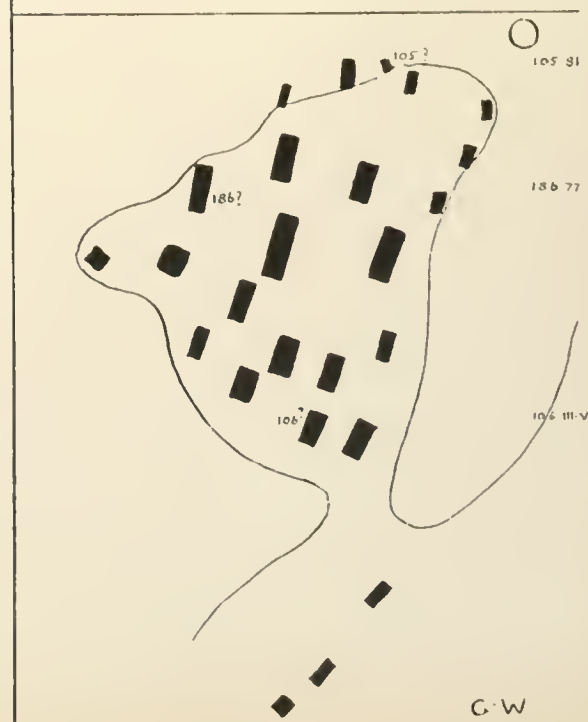
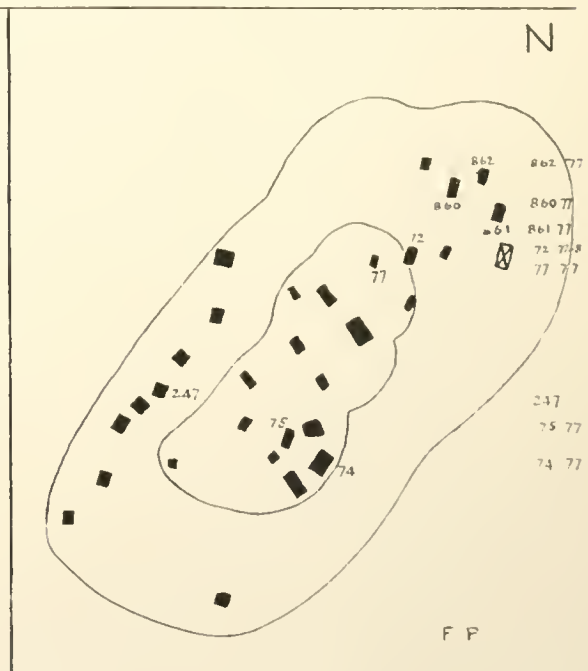
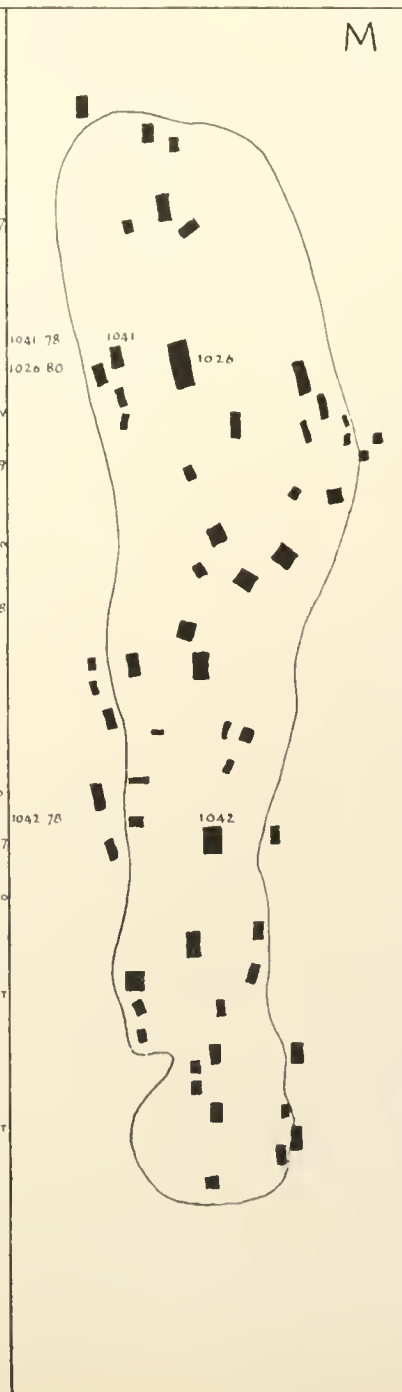
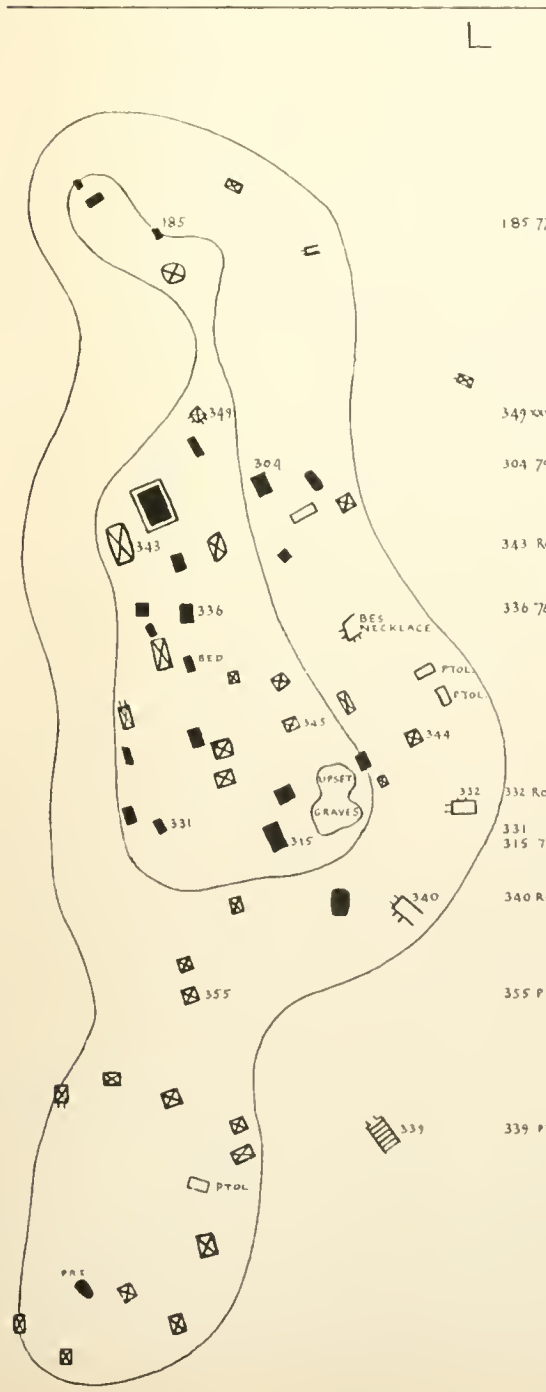
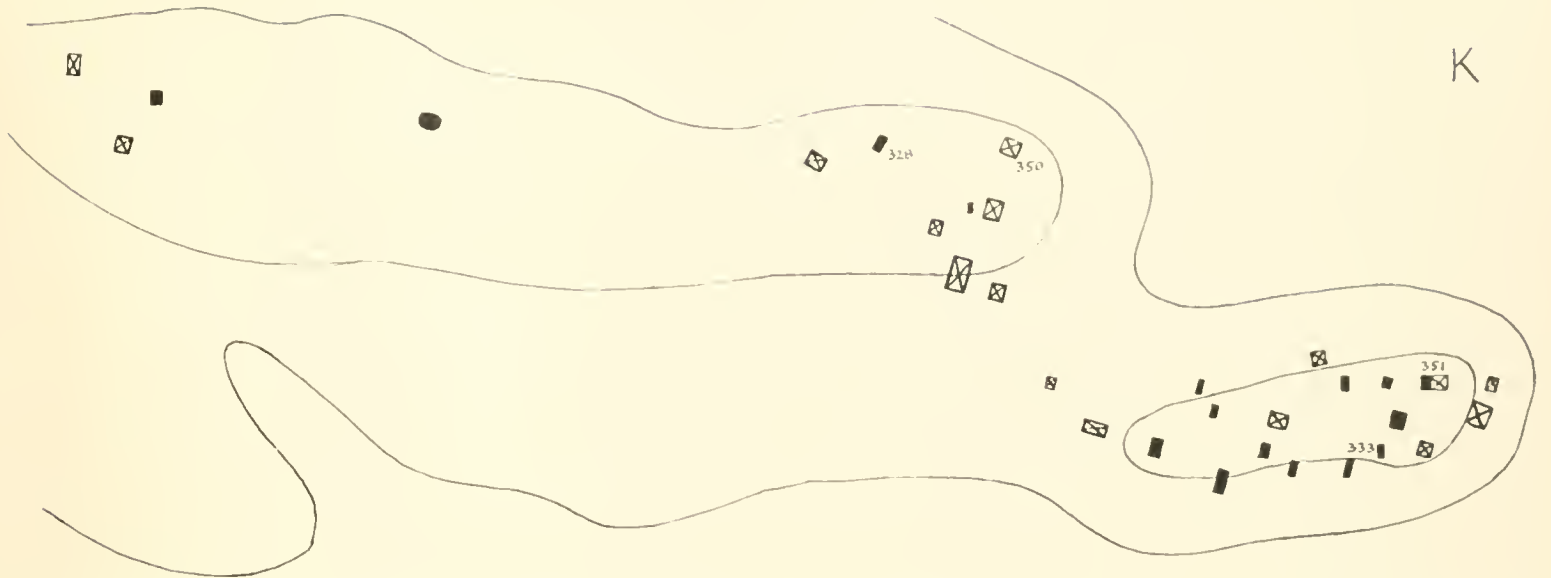

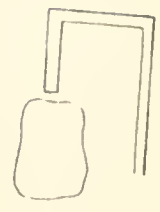
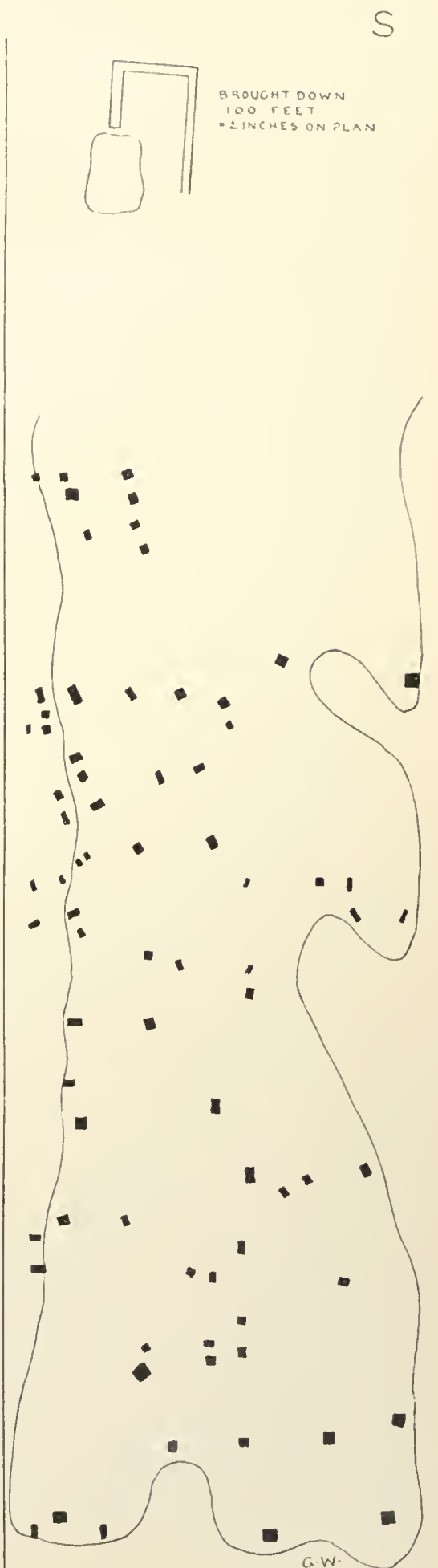
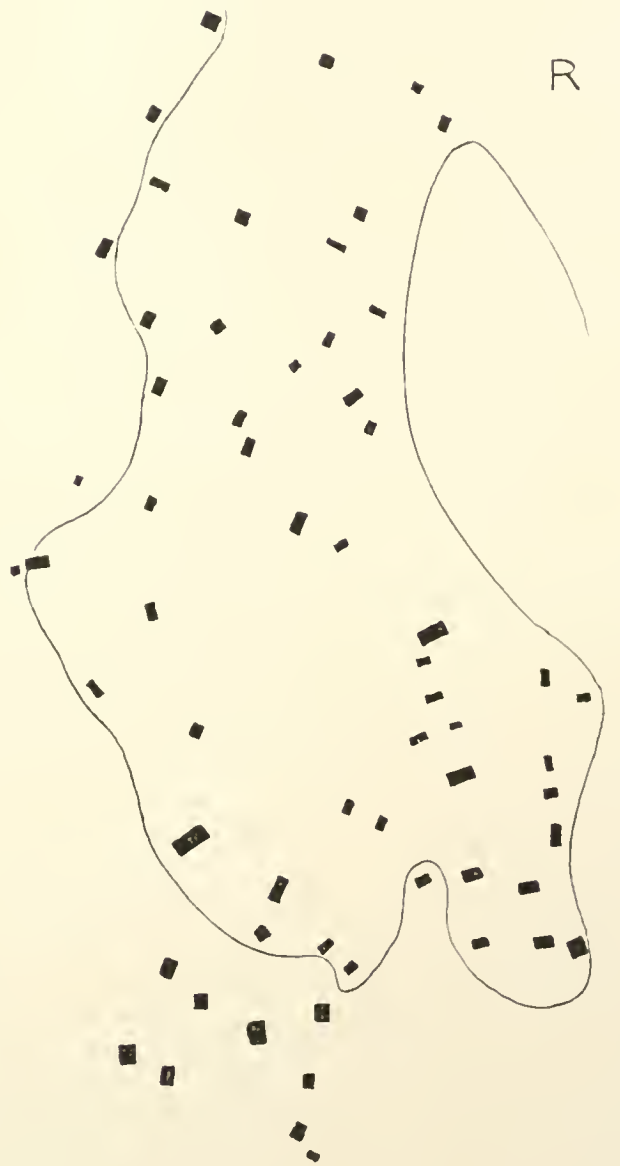
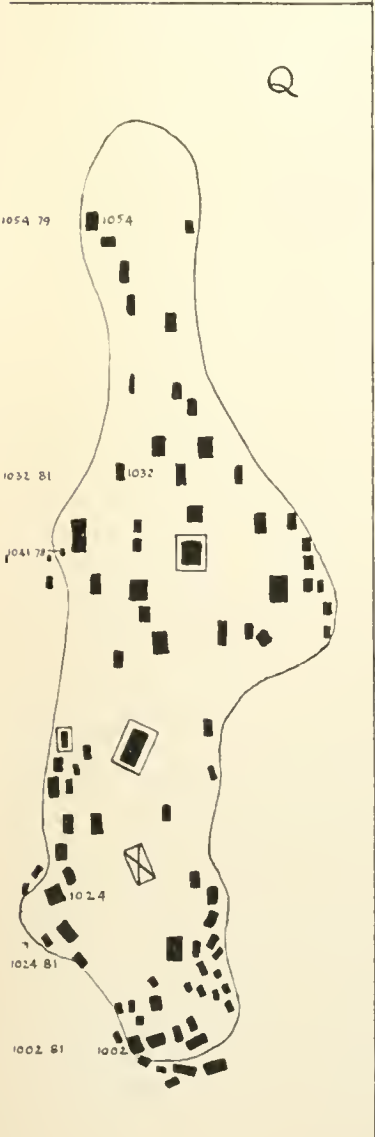
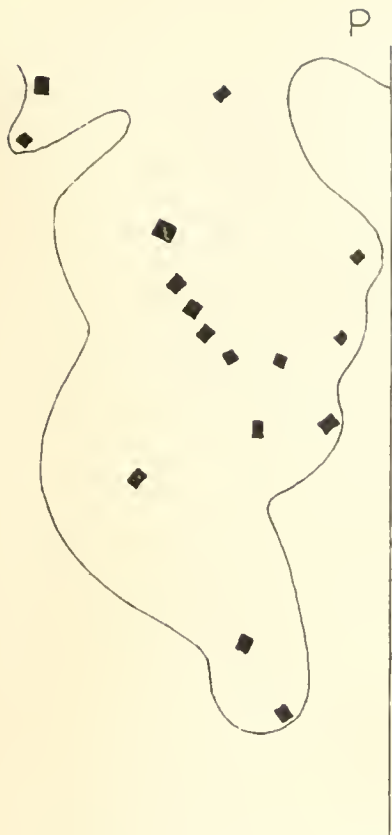











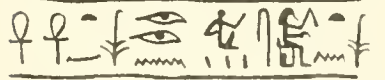

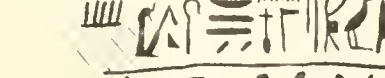



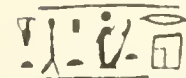

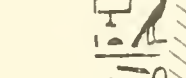
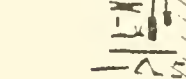
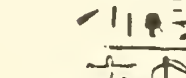





BROUGHT DOWN
100 FEET
= 2 INCHES ON PLAN

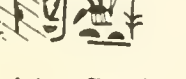

G.W.

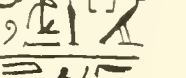
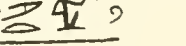

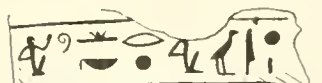
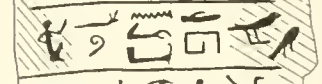



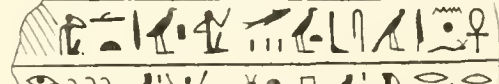

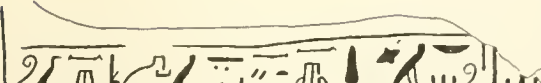

         	         	         	<p>1</p> <p>2</p> <p>3</p> <p>4</p> <p>5</p> <p>6</p> <p>7</p> <p>8</p> <p>9</p> <p>10</p>
--	--	--	--

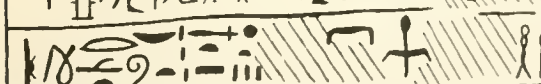
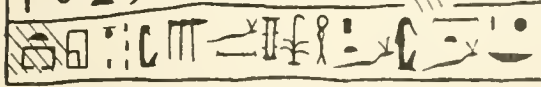
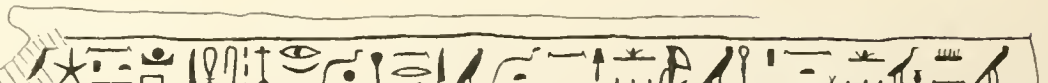
   	<p>11</p> <p>12</p> <p>13</p> <p>14</p>
---	---

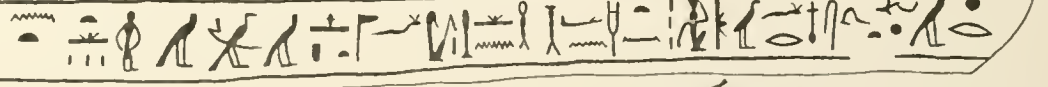
   	<p>11</p> <p>12</p> <p>13</p> <p>14</p>
---	---

   	   	<p>15</p> <p>16</p> <p>17</p> <p>18</p>
--	--	---

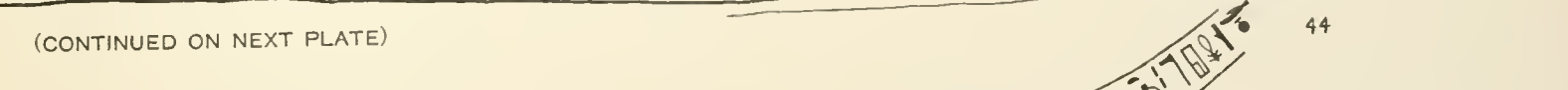
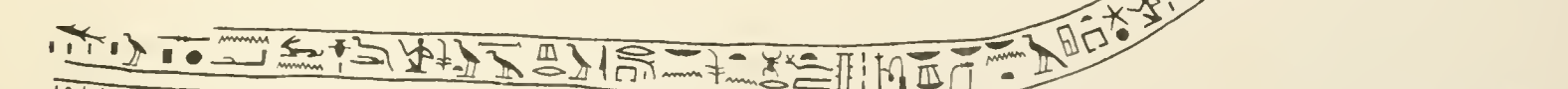
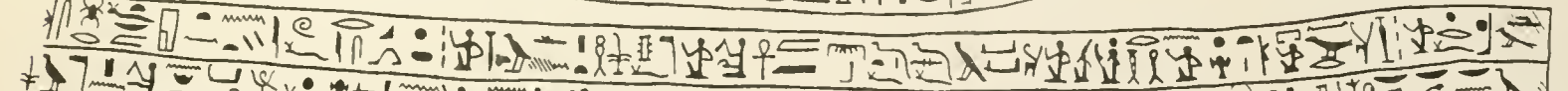
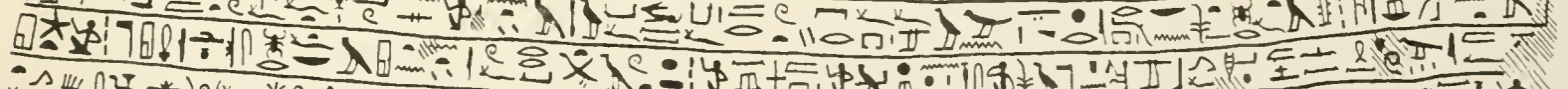
(CONTINUED ON NEXT PLATE)

    	<p>45</p> <p>46</p> <p>47</p> <p>48</p> <p>49</p>
---	---

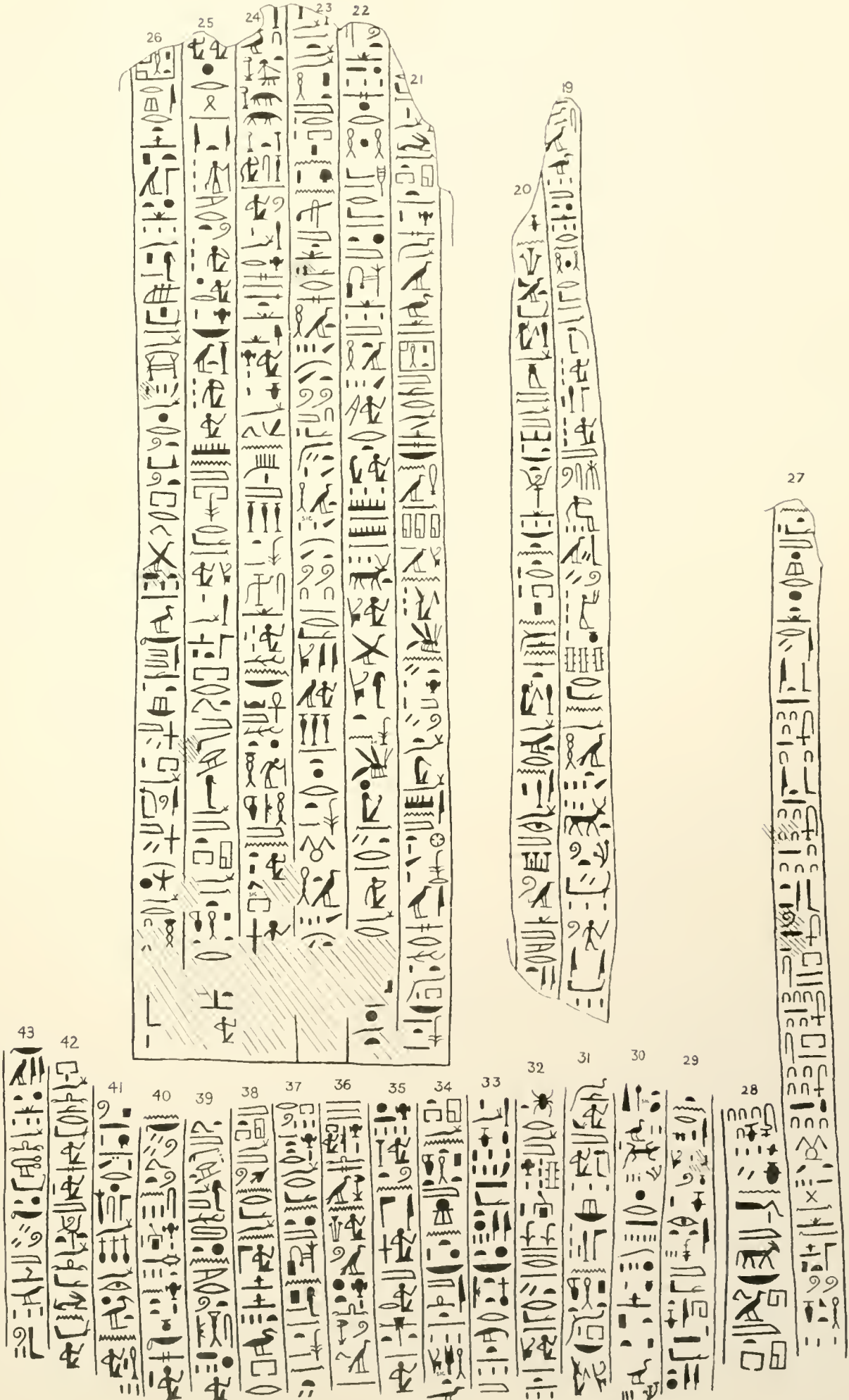

NYU IFA LIBRARY

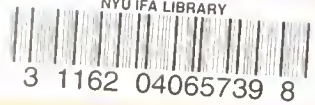

3 1162 04065739 8

**The Institute of Fine Arts
New York University**

**Stephen Chan Library
of
Fine Arts**



PUBLICATIONS

OF THE EGYPTIAN RESEARCH ACCOUNT AND BRITISH SCHOOL OF ARCHAEOLOGY IN EGYPT

- I. BALLAS, 1895; by J. E. QUIBELL. (Out of print; obtainable in joint volume NAQADA AND BALLAS, by W. M. F. PETRIE.)
- II. THE RAMESSEUM, 1896; by J. E. QUIBELL. (Out of print.)
- III. EL KAB, 1897; by J. E. QUIBELL.
- IV. HIERAKONPOLIS I, 1898; text by W. M. F. P. 43 plates. 20s. net.
- V. HIERAKONPOLIS II, 1899; by F. W. GREEN and J. E. QUIBELL. 39 plates (4 coloured and 20 photographic). 35s. net.
- VI. EL ARABAH, 1900; by J. GARSTANG. 40 plates. 16s. net. (Out of print.)
- VII. MAHASNA, 1901; by J. GARSTANG and KURT SETHE. 43 plates. (Out of print.)
- VIII. TEMPLE OF THE KINGS, 1902; by A. ST. G. CAULFEILD. 24 plates. 16s. net. (Out of print.)
- IX. THE OSIREION, 1903; by MARGARET A. MURRAY. 37 plates.
- X. SAQQARA MASTABAS I, 1904; by M. A. MURRAY; AND GUROB, by L. LOAT. 64 plates. 30s. net.
- XI. SAQQARA MASTABAS II, 1905; by HILDA PETRIE. (*In preparation.*)
- XII. HYKSOS AND ISRAELITE CITIES, 1906; by W. M. FLINDERS PETRIE and J. GARROW DUNCAN. 40 plates. 25s. net. In double volume with 94 plates. 45s. net. (This latter out of print.)
- XIII. GIZEH AND RIFEH, 1907; by W. M. FLINDERS PETRIE. 40 plates. 25s. net. In double volume with 109 plates. 50s. net.
- XIV. ATHRIBIS, 1908; by W. M. FLINDERS PETRIE, J. H. WALKER and E. B. KNOBEL. 43 plates. 25s. net. (Out of print.)
- XV. MEMPHIS I, 1908; by W. M. F. PETRIE & J. H. WALKER. 54 pls. 25s. net.
- XVI. QURNEH, 1909; by W. M. F. PETRIE & J. H. WALKER. 56 plates. (Out of print.)
- XVII. THE PALACE OF APRIES (MEMPHIS II), 1909; by W. M. FLINDERS PETRIE and J. H. WALKER. 35 plates. 25s. net.
- XVIII. MEYDUM AND MEMPHIS III, 1910; by W. M. F. PETRIE, E. MACKAY, and G. WAINWRIGHT. 47 plates. 25s. net.
- XIX. HISTORICAL STUDIES, 1910. 25 plates. 25s. net. (Studies, vol. ii.)
- XX. ROMAN PORTRAITS (MEMPHIS IV), 1911; by W. M. F. PETRIE. 35 plates. 25s. net.
- XXI. THE LABYRINTH AND GERZEH, 1911; by W. M. F. PETRIE, E. MACKAY, and G. WAINWRIGHT. 52 plates. 25s. net.
- XXII. PORTFOLIO OF HAWARA PORTRAITS. 24 coloured plates. 50s.
- XXIII. TARKHAN I AND MEMPHIS V, 1912. 81 plates. 25s. net.
- XXIV. HELIOPOLIS I AND KAFR AMMAR, 1912. (*In preparation.*)

Subscriptions of One Guinea for the Annual Single Volumes, or Two Guineas for the Two Annual Volumes, are received by the Hon. Secretary, at the Edwards Library, University College, Gower Street, London, W.C., where also copies of the above works can be obtained.

